

STANDARD HORIZON

Nothing takes to water like Standard Horizon

QUANTUM GX5500S

25 Watt VHF/FM
Marine Transceiver

Owner's Manual

- Commercial grade ITU-R M.493-13 Class D DSC transceiver
- Superior receiver performance (80 dB rejection)
- 30W loud hailer complete with listen-back and 4 fog horns, bells, and whistle
- 2.2 inch internal speaker producing clear load audio
- 2.58 x 1.28 inch dot matrix display
- Alphanumeric keypad allowing direct entry of channel numbers or selection of most used functions
- NAV mode displaying latitude/longitude, position time, SOG, and COG*
- Oversized rotary selector, volume and squelch
- Programmable scan, selectable priority scan, and dual watch
- One-button access to Channels 16 and 9
- Treble and bass audio tone control
- NMEA input and output of GPS information to other NMEA compatible devices
- Optional voice scrambler
- Plug and play front or rear panel microphone (optional MEK-4 extension cable available)
- Capable of connecting two RAM3 (CMP30) remote access microphones
- Optional Bluetooth communication unit

* When connected to a GPS receiver



TABLE OF CONTENTS







Quick Reference Guide.....	4	8.14 WIRELESS OPERATION.....	42
1 GENERAL INFORMATION.....	5	9 DIGITAL SELECTIVE CALLING.....	43
2 PACKING LIST.....	5	9.1 GENERAL.....	43
3 OPTIONAL ACCESSORIES.....	6	9.2 MARITIME MOBILE SERVICE IDENTITY (MMSI).....	43
4 ON-LINE WARRANTY REGISTRATION (in USA or Canada only).....	6	9.2.1 What is an MMSI?.....	43
5 GETTING STARTED.....	7	9.2.2 Programming the MMSI.....	44
5.1 PROHIBITED COMMUNICATIONS.....	7	9.3 DSC DISTRESS ALERT.....	45
5.2 ABOUT VHF RADIO.....	7	9.3.1 Transmitting a DSC Distress Alert.....	45
5.3 SELECTING AN ANTENNA.....	7	9.3.2 Receiving a DSC Distress Call.....	49
5.4 COAXIAL CABLE.....	8	9.4 ALL SHIPS CALL.....	50
5.5 EMERGENCY (CHANNEL 16 USE).....	8	9.4.1 Transmitting an All Ships Call.....	50
5.6 CALLING ANOTHER VESSEL (CHANNEL 16 OR 9).....	9	9.4.2 Receiving an All Ships Call.....	51
5.7 MAKING TELEPHONE CALLS.....	10	9.5 INDIVIDUAL CALL.....	52
5.8 OPERATING ON CHANNELS 13 AND 67.....	10	9.5.1 Setting up the Individual / Position Call Directory.....	52
5.9 AUTOMATED RADIO CHECK SERVICE.....	10	9.5.2 Setting up the Individual Call Reply.....	53
6 INSTALLATION.....	12	9.5.3 Setting up the Individual Call Acknowledgment.....	54
6.1 SAFETY / WARNING INFORMATION.....	12	9.5.4 Transmitting an Individual Call.....	55
6.2 LOCATION.....	12	9.5.5 Receiving an Individual Call.....	57
6.3 MOUNTING THE RADIO.....	13	9.5.6 Setting up the Individual Call Ringer.....	58
6.3.1 Supplied Mounting Bracket.....	13	9.6 GROUP CALL.....	59
6.3.2 Optional MMB-84 Flush Mount Bracket.....	14	9.6.1 Setting up the Group Call.....	59
6.4 ELECTRICAL CONNECTIONS.....	15	9.6.2 Transmitting a Group Call.....	61
6.5 ACCESSORY CABLES.....	16	9.6.3 Receiving a Group Call.....	63
6.6 CHECKING GPS STATUS.....	18	9.6.4 Setting up the Group Call Ringer.....	64
6.7 CHANGING THE GPS TIME.....	18	9.7 POSITION REQUEST.....	65
6.8 CHANGING THE TIME DISPLAY.....	19	9.7.1 Setting up the Position Reply.....	65
6.9 CHANGING COG TO TRUE OR MAGNETIC.....	20	9.7.2 Transmitting a Position Request to Another Vessel.....	66
6.10 TREBLE AND BASS AUDIO TONE CONTROL.....	21	9.7.3 Receiving a Position Request.....	68
6.11 OPTIONAL RAM3 (CMP30) INSTALLATION.....	21	9.7.4 Setting up the Position Request Ringer.....	69
6.11.1 Connecting an External Speaker to the RAM3 Mic Cable.....	23	9.8 POSITION REPORT.....	70
6.11.2 External Speaker AF Selection.....	23	9.8.1 Transmitting a DSC Position Report Call.....	70
6.12 EXTRA MICROPHONE INSTALLATION.....	24	9.8.2 Receiving a DSC Position Report Call.....	72
7 CONTROLS AND INDICATORS.....	25	9.8.3 Setting up the Position Report Ringer.....	72
7.1 FRONT PANEL.....	25	9.9 MANUAL INPUTTING A GPS POSITION (LAT/LON).....	73
7.2 REAR PANEL.....	30	9.10 DSC TEST CALL.....	74
7.3 MICROPHONE.....	31	9.10.1 DSC Test Call by using Individual/Position Call Directory.....	74
8 BASIC OPERATION.....	32	9.10.2 DSC Test Call by Manually Entering a MMSI.....	75
8.1 RECEPTION.....	32	9.10.3 Receiving a DSC Test Call.....	76
8.2 TRANSMISSION.....	32	9.11 POLLING CALL.....	77
8.3 TRANSMIT TIME - OUT TIMER (TOT).....	33	9.11.1 Transmitting a Polling Call to Another Vessel.....	77
8.4 SIMPLEX/DUPLEX CHANNEL USE.....	33	9.11.2 Receiving a Polling Call.....	78
8.5 DISPLAYING SOG AND COG INFORMATION.....	33	9.12 DSC LOG OPERATION.....	79
8.6 ADJUSTING DIMMER.....	33	9.12.1 Reviewing Logged DSC Distress Calls.....	79
8.7 USA, CANADA, AND INTERNATIONAL MODE.....	34	9.12.2 Reviewing Other Logged Calls.....	80
8.8 NOAA WEATHER CHANNELS.....	34	9.12.3 Deleting a Call from the "DSC LOG" Directory.....	80
8.8.1 NOAA Weather Alert.....	34	10 RADIO SETUP.....	82
8.8.2 NOAA Weather Alert Testing.....	35	10.1 CONTRAST.....	82
8.9 DUAL WATCH (TO CHANNEL 16).....	35	10.2 TIME OFFSET.....	82
8.10 SCANNING.....	36	10.3 TIME DISPLAY.....	82
8.10.1 Scan Type Selection.....	36	10.4 SOG UNIT.....	83
8.10.2 Scan Channel Memory Programming.....	36	10.5 MAGNETIC.....	83
8.10.3 Memory Scanning (M-SCAN).....	37	10.6 PRIORITY CHANNEL.....	83
8.10.4 Priority Scanning (P-SCAN).....	37	10.7 SCAN TYPE.....	84
8.11 PA/FOG OPERATION.....	38	10.8 SCAN RESUME TIME.....	84
8.11.1 Operating the PA/HAILER mode.....	38	10.9 KEY BEEP.....	85
8.11.2 Operating the FOG HORN mode.....	39	10.10 WEATHER ALERT.....	85
8.11.3 Fog Signal Timing Chart.....	40	10.11 CHANNEL NAME.....	86
8.12 INTERCOM OPERATION.....	41	10.12 UNIT NAME.....	87
8.12.1 Communication.....	41	10.13 TREBLE AND BASS AUDIO TONE CONTROL.....	88
8.12.2 Calling.....	41	10.14 FOG ALERT TONE FREQUENCY.....	88
8.13 VOICE SCRAMBLER.....	42	10.15 CALENDAR SETUP.....	89

TABLE OF CONTENTS

11 DSC SETUP	92
11.1 INDIVIDUAL DIRECTORY	92
11.2 INDIVIDUAL REPLY	92
11.3 INDIVIDUAL ACKNOWLEDGMENT	92
11.4 INDIVIDUAL RINGER	92
11.5 GROUP DIRECTORY	92
11.6 POSITION REPLY	93
11.7 DSC BEEP	93
11.8 AUTO CHANNEL SWITCH TIME	94
11.9 NO ACTION TIMER ON MENU OPERATION	94
11.10 NO ACTION TIMER ON DSC OPERATION	95
11.11 NO ACTION TIMER ON DISTRESS OPERATION	95
12 BLUETOOTH SETUP	96
12.1 VOX FUNCTION	96
12.2 SAVE FUNCTION	96
12.3 PIN CODE	97
12.4 PAIRING	97
13 RAM3 (CMP30) REMOTE MIC OPERATION	98
13.1 REMOTE MIC CONTROLS	98
13.2 ASSIGNING SOFT KEYS	100
14 MAINTENANCE	102
14.1 REPLACEMENT PARTS	102
14.2 FACTORY SERVICE	103
14.3 TROUBLESHOOTING CHART	104
15 CHANNEL ASSIGNMENTS	105
16 WARRANTY	111
17 SPECIFICATIONS	115
17.1 GENERAL	115
17.2 TRANSMITTER	115
17.3 RECEIVER	116
17.4 DIMENSIONS	117
18 FCC RADIO LICENSE INFORMATION	119
18.1 STATION LICENSE	119
18.2 RADIO CALL SIGN	119
18.3 CANADIAN SHIP STATION LICENSING	119
18.4 FCC / INDUSTRY CANADA INFORMATION	119
19 FCC NOTICE	120



QUICK REFERENCE GUIDE

The **GX5500S** is equipped with the E2O (Easy-To-Operate) system. You can do the basic operation in numerical order in the illustration below.

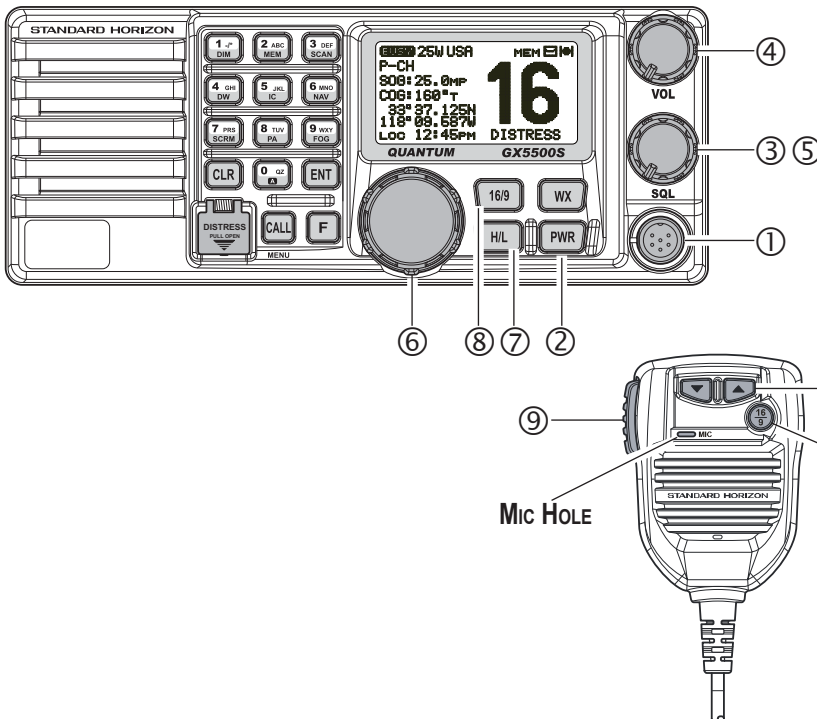
- ① Connect the supplied hand microphone.
- ② Press and hold the **PWR** key to turn on or off the radio.
- ③ Rotate the **SQL** knob counter clockwise to unsquelch the radio.
- ④ Rotate the **VOL** knob to adjust the speaker audio volume.
- ⑤ Rotate the **SQL** knob clockwise to the point where the noise not heard from the speaker.
- ⑥ Rotate the **DIAL** knob (or press the microphone's  /  keys) to select the operating channel.
- ⑦ Press the **H/L** key to toggle the transmit power between High (25W) and Low (1W).
- ⑧ Press the  (or microphone's ) key to recall Channel 16.
Press and hold the  (or microphone's ) key to recall Channel 9.
Press again to revert to the last selected channel.
- ⑨ Place your mouth about 1/2 inch away from Mic hole and speak in a normal voice level while pressing the **PTT** switch.



1 GENERAL INFORMATION

The STANDARD HORIZON QUANTUM **GX5500S** marine VHF/FM marine transceiver is capable of ITU-R 493-13 DSC (Digital Selective Calling) class D operation. The class D operation allows continuous receiving of digital selective calling functions on channel 70 even if the radio is receiving a call. The **GX5500S** VHF operates on all currently-allocated marine channels which are switchable for USA, International, or Canadian regulations. Emergency Channel 16 can be immediately selected from any channel by pressing the red  key. NOAA Weather channels can also be accessed immediately by pressing the  key.

The **GX5500S** can be operated from 11 to 16 VDC and has a switchable RF output power of 1 watt or 25 watts.

Other features of the **GX5500S** VHF's include: removable microphone with controls, optional **RAM3** second station remote-control microphone with display, intercom between radio and optional **RAM3**, scanning, priority scanning, dual watch, high and low voltage warning, and GPS repeatability.

2 PACKING LIST

When the package containing the transceiver is first opened, please check it for the following contents:

- **GX5500S** Transceiver
- Hand Microphone
- Power Cord with Fuse Holder
- Mounting Bracket and Hardware
- Owner's Manual
- DSC Warning Sticker

3 OPTIONAL ACCESSORIES

MMB-84	Flush-mount bracket
CMP30B/W	Remote-access microphone (RAM3 Mic, Black/White)
CT-100	23-foot extension cable for RAM3 Mic
CVS2500	Voice scrambler
MLS-310	10W amplified external speaker with on/off volume control
MLS-300	External loud speaker
220SW	4.5" round PA/Hailer horn
240SW	5" x 8" rectangular PA/Hailer horn
MEK-4	23-foot microphone extension kit (for connection to rear panel)
BH-2A	Bluetooth headset
BU-1	Bluetooth adapter unit

4 ON-LINE WARRANTY REGISTRATION (in USA or Canada only)

Please visit www.standardhorizon.com to register the **GX5500S** marine VHF. It should be noted that visiting the website from time to time may be beneficial to you, as new products are released they will appear on the STANDARD HORIZON website.

PRODUCT SUPPORT INQUIRIES

If you have any questions or comments regarding the use of the **GX5500S**, you can visit the STANDARD HORIZON website to send an E-Mail (marinetech@yaesu.com) or contact the Product Support team at (800) 767-2450 M-F 8:00AM to 5:00PM PST.

5 GETTING STARTED

5.1 PROHIBITED COMMUNICATIONS

The FCC prohibits the following communications:

- False distress or emergency messages;
- Messages to “any boat” except in emergencies and radio tests;
- Messages to or from a vessel on land;
- Transmission while on land;
- Obscene, indecent, or profane language (potential fine of \$10,000).

5.2 ABOUT VHF RADIO

The radio frequencies used in the VHF marine band lie between 156 and 158 MHz with some shore stations available between 161 and 163 MHz. The marine VHF band provides communications over distances that are essentially “line of sight” (VHF signals do not travel well through objects such as buildings, hills or trees). Actual transmission range depends much more on antenna type, gain and height than on the power output of the transmitter. On a fixed mount 25W radio transmission expected distances can be greater than 15 miles.

5.3 SELECTING AN ANTENNA

Marine antennas are made to radiate signals equally in all horizontal directions, but not straight up. The objective of a marine antenna is to enhance the signal toward the horizon. The degree to which this is accomplished is called the antenna’s gain. It is measured in decibels (dB) and is one of the major factors in choosing an antenna. In terms of effective radiated power (ERP), antennas are rated on the basis of how much gain they have over a theoretical antenna with zero gain. A 3-foot, 3dB gain antenna represents twice as much gain over the imaginary antenna.

Typically a 3-foot 3dB gain stainless steel whip is used on a sailboat mast. The longer 8-foot 6dB fiberglass whip is primarily used on power boats that require the additional gain.

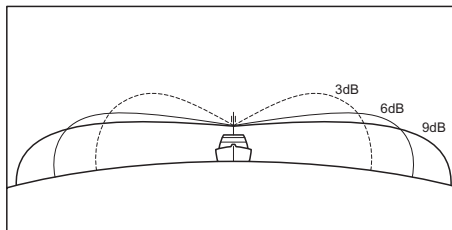

5.4 COAXIAL CABLE

VHF antennas are connected to the transceiver by means of a coaxial cable – a shielded transmission line. Coaxial cable is specified by its diameter and construction.

For runs less than 20 feet, RG-58/U, about 1/4 inch in diameter is a good choice. For runs over 20 feet but less than 50 feet, the larger RG-8X or RG-213/U should be used for cable runs over 50 feet RG-213/U should be used. For installation of the connector onto the coaxial cable refer to the figure below.

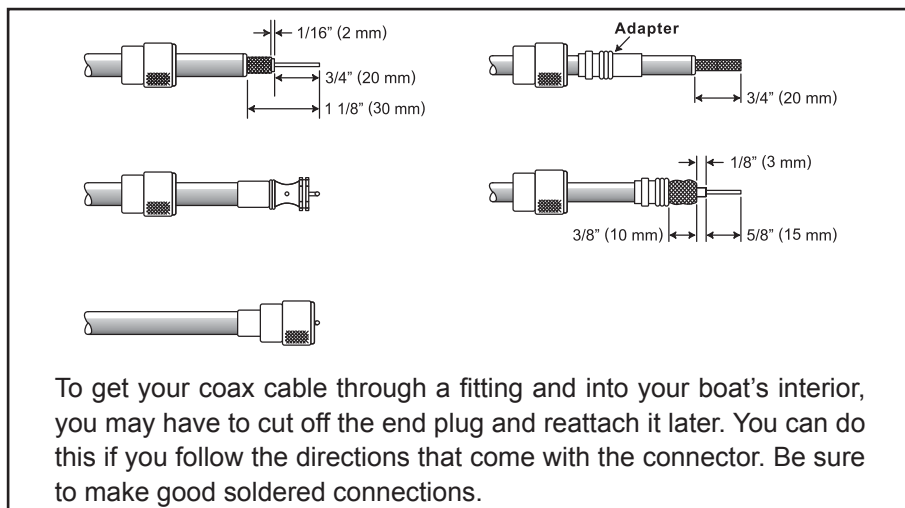

5.5 EMERGENCY (CHANNEL 16 USE)

Channel 16 is known as the Hail and Distress Channel. An emergency may be defined as a threat to life or property. In such instances, be sure the transceiver is on and set to CHANNEL 16. Then use the following procedure:

1. Press the microphone push-to-talk switch and say "**Mayday, Mayday, Mayday**. This is _____, _____, _____" (your vessel's name).
2. Then repeat once: "**Mayday, _____**" (your vessel's name).
3. Now report your position in latitude/longitude, or by giving a true or magnetic bearing (state which) to a well-known landmark such as a navigation aid or geographic feature such as an island or harbor entry.
4. Explain the nature of your distress (sinking, collision, aground, fire, heart attack, life-threatening injury, etc.).
5. State the kind of assistance your desire (pumps, medical aid, etc.).

6. Report the number of persons aboard and condition of any injured.
7. Estimate the present seaworthiness and condition of your vessel.
8. Give your vessel's description: length, design (power or sail), color and other distinguishing marks. The total transmission should not exceed 1 minute.
9. End the message by saying "**OVER**". Release the microphone button and listen.
10. If there is no answer, repeat the above procedure. If there is still no response, try another channel.

NOTE

The **GX5500S** has DSC distress calling, that can transmit a distress call digitally to all ships with compatible DSC radios. Refer to section "**9 DIGITAL SELECTIVE CALLING**".

5.6 CALLING ANOTHER VESSEL (CHANNEL 16 OR 9)

Channel 16 may be used for initial contact (hailing) with another vessel. However, its most important use is for emergency messages. This channel must be monitored at all times except when actually using another channel.

Channel 16 is monitored by the U.S. and Canadian Coast Guards and by other vessels. **Use of channel 16 for hailing must be limited to initial contact only.** Calling should not exceed 30 seconds, but may be repeated 3 times at 2-minute intervals. In areas of heavy radio traffic, congestion on channel 16 resulting from its use as a hailing channel can be reduced significantly in U.S. waters by using **channel 9** as the initial contact (hailing) channel for non-emergency communications. Also hailing on channel 9, the calling time should not exceed 30 seconds but may be repeated 3 times at 2-minute intervals.

Prior to making contact with another vessel, refer to the channel charts in this manual, and select an appropriate channel for communications after initial contact. For example, Channels 68 and 69 of the U.S. VHF Charts are some of the channels available to non-commercial (recreational) boaters. Monitor your desired channel in advance to make sure you will not be interrupting other traffic, and then go back to either channel 16 or 9 for your initial contact.

When the hailing channel (16 or 9) is clear, press the **PTT** (push-to-talk) switch on the mic and state the name of the other vessel you wish to call and then "**this is**" followed by the name of your vessel and your Station License (Call Sign) then release the **PTT** switch on the mic. When the other vessel returns your call, immediately request another channel by pressing the **PTT**

switch on the mic and saying “**go to**,” the number of the other channel, say “**over**” and release the **PTT** switch on the mic. Then switch to the new channel. When the new channel is not busy, call the other vessel.

After a transmission, say “**over**,” and release the microphone’s **PTT** switch. When all communication with the other vessel is completed, end the last transmission by stating your Call Sign and the word “**out**.” Note that it is not necessary to state your Call Sign with each transmission, only at the beginning and end of the contact.

Remember to return to Channel 16 when not using another channel. Some radios automatically monitor Channel 16 even when set to other channels or when scanning.

5.7 MAKING TELEPHONE CALLS

To make a radiotelephone call, use a channel designated for this purpose. Check with your local marina to learn which channels are used for radiotelephone traffic. Channels available for such traffic are designated **Public Correspondence** channels on the channel charts in this manual. Some examples for USA use are the channels 24, 25, 26, 27, 28, 84, 85, 86, and 87. Call the marine operator and identify yourself by your vessel’s name, the marine operator will then ask you how you will pay for the call (telephone credit card, collect, etc.) and then link your radio transmission to the telephone lines.

The marine telephone company managing the VHF channel you are using may charge a link-up fee in addition to the cost of the call.

5.8 OPERATING ON CHANNELS 13 AND 67

Channel 13 is used at docks, bridges and by vessels maneuvering in port. Messages on this channel must concern navigation only, such as meeting and passing in restricted waters.

Channel 67 is used for navigational traffic between vessels.

By regulation, power is normally limited to 1 Watt on these channels. Your radio is programmed to automatically reduce power to this limit on these channels. However, in certain situations it may be necessary to temporarily use a higher power. See page 26 ( key) for means to temporarily override the low-power limit on these two channels.

5.9 AUTOMATED RADIO CHECK SERVICE

In areas across the country, Sea Tow offers boaters a way to conduct radio checks. To use Sea Tow’s free Automated Radio Check service, simply tune

your VHF radio to the appropriate channel for your location and conduct a radio check as you typically would. Upon releasing your radio's microphone, the system will play an automated message and relay your transmission back to you, thereby letting you know how your signal will sound to other boaters.

The Automated Radio Check Service is currently available in the areas listed below.

West Coast	South Carolina
Newport/LA - Ch. 27	Charleston - Ch. 27
San Diego - Ch. 27	Georgetown - Ch. 27
Northeast	Myrtle Beach - Ch. 27
Central Connecticut - Ch. 24	Gulf of Mexico
Eastern Connecticut - Ch. 27	Galveston Bay - Ch. 27
Southern Connecticut - Ch. 24	Mobile - Ch. 26
Portland-Midcoast (Maine) - Ch. 27	New Orleans - Ch. 27
Boston - Ch. 27	Pensacola/Orange Beach (Ala.) - Ch. 27
Cape and Islands - Ch. 28	Georgia
South Shore (Mass.) - Ch. 26	Brunswick - Ch. 27
Rhode Island - Ch. 24	Tennessee
Central Hudson (NY) - Ch. 24	Fort Loudon - Ch. 28
Eastern Long Island - Ch. 28	Florida
Freeport (N.Y.) - Ch. 24	Carrabelle/St. Marks - Ch. 26 & 27
Great South Bay (N.Y.) - Ch. 27	Charlotte Harbor - Ch. 26
Lower New York - Ch. 28	Clearwater/Port Richey - Ch. 26 & 27
Huntington (N.Y.) - Ch. 28	Daytona - Ch. 26
Port Jefferson - Ch. 27	Destin - Ch. 26 & 27
Shinnecock / Moriches (N.Y.) - Ch. 24 & 27	Fort Lauderdale - Ch. 27
Services International (Southold) - Ch. 28	Fort Myers - Ch.27
Western LI Sound - Ch. 27	Horseshoe Beach - Ch. 26
Manasquan (N.J.) - Ch. 24	Islamorada - Ch. 26
Northern New Jersey - Ch. 27	Jacksonville - Ch. 27
Mid-Atlantic	Key Biscayne - Ch. 26
Atlantic City (NJ) - Ch. 26	Key Largo - Ch. 27
Central New Jersey (NJ) - Ch. 27	Marco Island - Ch. 27
Sea Isle / Cape May (NJ) - Ch. 26	Naples - Ch. 26
Delaware River (DE) - Ch. 26	Palm Beach - Ch. 26
Northern Chesapeake (Md.) - Ch. 27	Panama City - Ch. 27
Central Chesapeake (Md.) - Ch. 27	Pensacola - Ch. 26 & 27
Lower Chesapeake(Va.) - Ch. 26	Port Canaveral - Ch. 26
Hampton Roads (Va.) - Ch. 28	Port St. Joe - Ch. 26
North Carolina	Sarasota - Ch. 26
Albermarle Sound- Ch. 27	Sebastian - Ch. 27
Crystal Coast- Ch. 27	St. Augustine - Ch. 26
Ocean Isle Beach - Ch. 26	Services International (Summerland Keys) - Ch. 27
Oregon Inlet- Ch. 27	Tampa Bay - Ch. 27
Pamlico Sound - Ch. 27	Treasure Coast - Ch. 27
Wrightsville Beach - Ch. 26 & 27	Venice - Ch. 27
Puerto Rico	Virgin Islands
Puerto Rico - Ch. 26 & 27	Virgin Islands - Ch. 27

6 INSTALLATION

6.1 SAFETY / WARNING INFORMATION

This radio is restricted to occupational use, work related operations only where the radio operator must have the knowledge to control the exposure conditions of its passengers and bystanders by maintaining the minimum separation distance of 3 feet (1 m). Failure to observe these restrictions will result in exceeding the FCC RF exposure limits.

Antenna Installation:

The antenna must be located at least 3 feet (1 m) away from passengers in order to comply with the FCC RF exposure requirements.

Lithium Battery Included:

This radio contains a lithium battery. At the end of radio's useful life, under various state and lows, it may be illegal to dispose of lithium battery into the municipal waste stream. Check with your local solid waste officials for details in your area for recycling options or proper disposal.

6.2 LOCATION

The radio can be mounted at any angle. Choose a mounting location that:

- is far enough from any compass to avoid any deviation in compass reading due to the speaker magnet
- provides accessibility to the front panel controls
- allows connection to a power source and an antenna
- has nearby space for installation of a microphone hanger
- is at least 3 feet (1 m) away from the radio's antenna.

Note: To insure the radio does not affect the compass or radios performance is not affected by the antenna location, temporarily connect the radio in the desired location and:

- a. Examine the compass to see if the radio causes any deviation
- b. Connect the antenna and key the radio. Check to ensure the radio is operating correctly by requesting a radio check.

6.3 MOUNTING THE RADIO

6.3.1 Supplied Mounting Bracket

The supplied mounting bracket allows overhead or desktop mounting.

See illustration on next page, use a 13/64" (5.2 mm) bit to drill the holes to a surface which is more 0.4 inch (10 mm) thick and can support more than 3.3 lbs (1.5 kg) and secure the bracket with the supplied screws, spring washers, flat washers, and nuts.

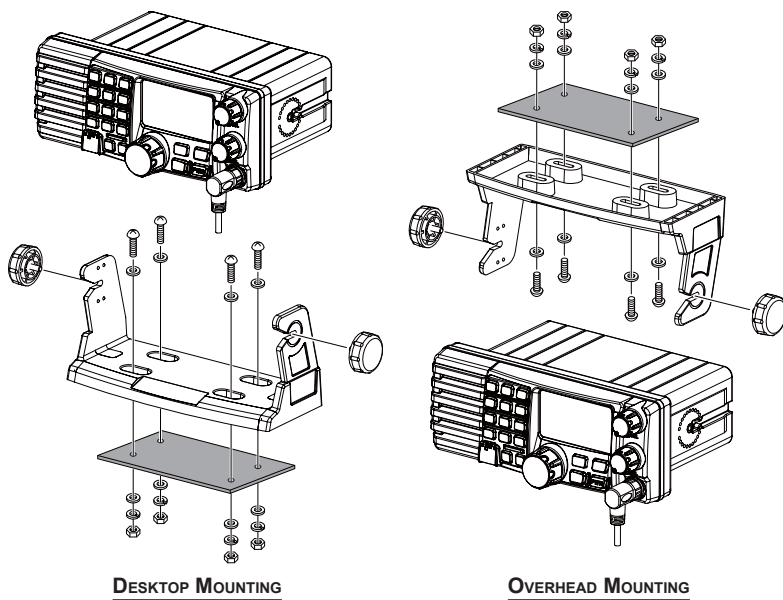

6.3.2 Optional MMB-84 Flush Mount Bracket

1. Make a rectangular template for the flush mount measuring 2.9" H x 8.1" W (72 x 205 mm).
2. Use the supplied template to mark the location where the rectangular hole is to be cut. Confirm the space behind the dash or panel is deep enough to accommodate the transceiver (at least 6 inches (150 mm) deep). There should be at least 1/2 inch (1.3 cm) between the transceiver's heatsink and any wiring, cables or structures.
3. Cut out the rectangular hole and insert the transceiver.
4. Fasten the brackets to the side of the transceiver with the lock-washer nut combination; so that the mounting screw base faces the mounting surface (see the illustration below).
5. Turn the adjusting screw to adjust the tension so that the transceiver is tight against the mounting surface.

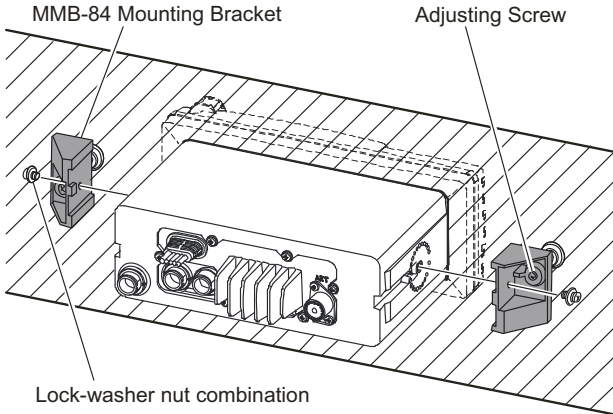

6.4 ELECTRICAL CONNECTIONS

CAUTION

Reverse polarity battery connections will damage the radio!

Connect the power cord and antenna to the radio. Antenna and Power Supply connections are as follows:

1. Mount the antenna at least 3 feet (1 m) away from the radio. At the rear of the radio, connect the antenna cable. The antenna cable must have a PL259 connector attached. RG-8/U coaxial cable must be used if the antenna is 25 feet (7.6 m) or more from the radio. RG58 cable can be used for distances less than 25 feet (7.6 m).
2. Connect the red power wire to a 11.0 V to 16.5 V DC power source (Normal: 13.8 VDC). Connect the black power wire to a negative ground.
3. If an optional remote extension speaker is to be used, refer to section “6.5 **ACCESSORY CABLES**” for connections.
4. Connect the supplied hand microphone to the connector on the front panel.

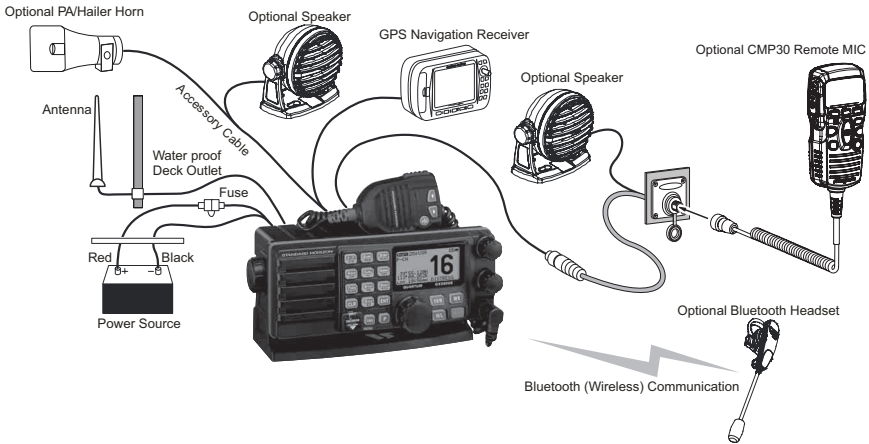

It is advisable to have a Certified Marine Technician check for the power output and the standing wave ratio of the antenna after installation.

Fuse Replacement (125V 6A)

To take out the fuse from the fuse holder, hold both ends of the fuse holder and pull the fuse holder apart without bending. When you replace the fuse, please confirm that the fuse is tightly fixed on the metal contact located inside the fuse holder. If the metal contact holding the fuse is loose, the fuse holder may heat up.

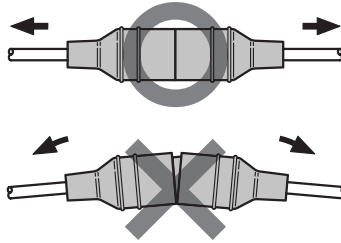

6.5 ACCESSORY CABLES

Wire Color/Description	Connection Examples
WHITE - External Speaker (+)	Connect to external 4 Ohm audio speaker
SHIELD - External Speaker (-)	Connect to external 4 Ohm audio speaker
RED - PA Speaker (+)	Connect to external 4 Ohm PA speaker
SHIELD - PA Speaker (-)	Connect to external 4 Ohm PA speaker
BLUE - NMEA GPS Input (+)	Connect to NMEA (+) output of GPS
GREEN - NMEA GPS Input (-)*	Connect to NMEA (-) output or common ground of GPS
GRAY - NMEA DSC Output (+)	Connect to NMEA (+) input of GPS
BROWN - NMEA GPS Output (-)*	Connect to NMEA (-) input of GPS

※: Some GPS chart plotters have a single wire for NMEA signal ground. In such a case connect the NMEA input (-) to the GPS chart plotter's single NMEA signal ground wire, and leave the NMEA output (-) open. In case the assignment of power supply and ground of a GPS chart plotter to be used is different from that of the radio, connect the signal ground wire of the GPS chart plotter to the ground terminal (GND) on the rear panel of the radio.

When connecting the external speaker, chart plotter, or external GPS antenna, strip off about 1 inch (2.5 cm) of the specified wire's insulation, then splice the ends together.

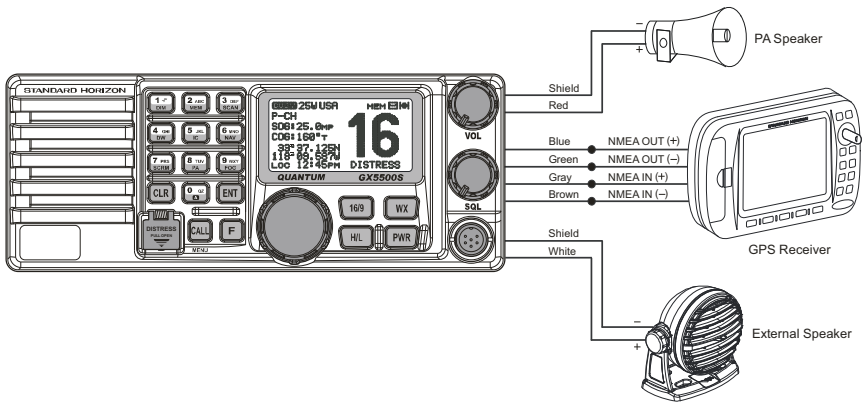

In some areas powerful AM broadcast stations may be heard when in listen-back mode. In this case change the speaker wire to 2-conductor shielded audio cable. See the illustration below for connections.

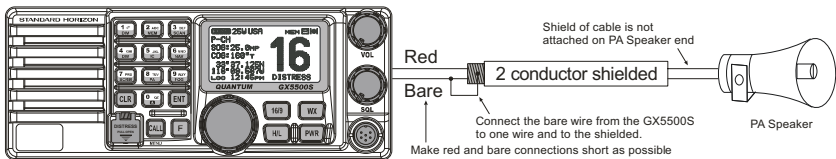

External GPS Connections (4800 baud)

NMEA Input (GPS Information)

- The GPS must have the NMEA output turned on and set to 4800 baud in the setup menu. If there is a selection for parity select none.
- For further information on interfacing /setting up your GPS. Please contact the manufacturer of the GPS receiver.
- The **GX5500S** can read NMEA-0183 version 2.0 or higher.
- The NMEA 0183 input sentences are GLL, GGA, RMC and GNS (RMC sentence is recommended for position information).

NMEA Output (DSC and GPS Information)

- The NMEA 0183 output sentences are DSC and DSE.

If you have further inquires, please feel free to contact Product Support at:

Phone: (800) 767-2450

Email: marinetech@yaesu.com

6.6 CHECKING GPS STATUS

When turning on the radio after connections have been made between the **GX5500S** and the GPS, a small satellite icon (📶) will appear on the top right corner of the display and your current location (latitude/longitude) will be shown on the display.

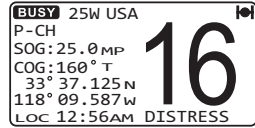

NOTE

If there is a problem with the NMEA connection between the radio and the GPS, the GPS icon will blink continuously until the connection is corrected.

When you input your location manually,

6.7 CHANGING THE GPS TIME

From the factory the **GX5500S**, when connected to an optional GPS, will display GPS satellite time or UTC (Universal Time Coordinated). A time offset is needed to show the local time in your area. Please see the time offset table in the next page.

1. Press and hold the **[CALL]** key until "Setup Menu" appears, then select "Radio Setup" with the **DIAL** knob.
2. Press the **[ENT]** key, then select "Time Offset" with the **DIAL** knob.
3. Press the **[ENT]** key, then rotate the **DIAL** knob to select time offset of your location. See illustration in the next page to find your offset time. If "00:00" is assigned, the time is the same as UTC (Universal Time Coordinated or GPS Satellite Time).
4. Press the **[ENT]** key to store the time offset.
5. Press the **[CLR]** key twice to return to radio operation.

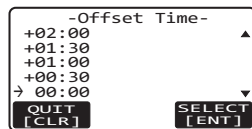
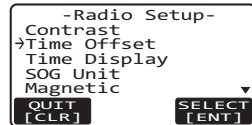

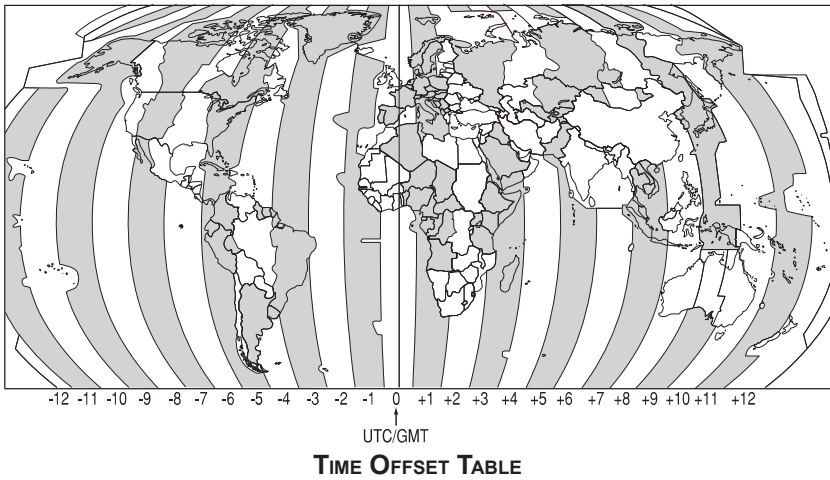

6.8 CHANGING THE TIME DISPLAY

This menu selection allows the radio to show UTC (Universal Time Coordinated or GPS Satellite Time) or local time with the offset.

1. Press and hold the **[CALL]** key until “Setup Menu” appears, then select “Radio Setup” with the **DIAL** knob.
2. Press the **[ENT]** key, then rotate the **DIAL** knob to select “Time Display”.
3. Press the **[ENT]** key.
4. Rotate the **DIAL** knob to select “UTC” or “Local”.
5. Press the **[ENT]** key to store the selected setting.
6. Press the **[CLR]** key twice to return to radio operation.

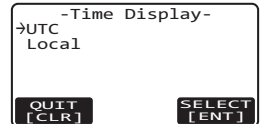
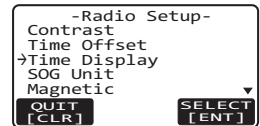

6.9 CHANGING COG TO TRUE OR MAGNETIC

Allows the GPS COG (Course Over Ground) to be selected to show in “True” or “Magnetic”. Factory default is “True” however by following the steps below the COG can be changed to “Magnetic”.

1. Press and hold the **CALL** key until “Setup Menu” appears, then select “Radio Setup” with the **DIAL** knob.
2. Press the **ENT** key, then rotate the **DIAL** knob to select “Magnetic”.
3. Press the **ENT** key.
4. Rotate the **DIAL** knob to select “Magnetic” or “True”.
5. Press the **ENT** key to store the selected setting.
6. Press the **CLR** key twice to return to radio operation.

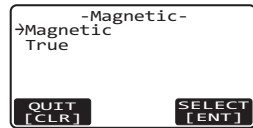
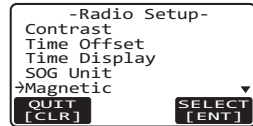
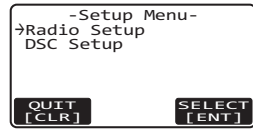

6.10 TREBLE AND BASS AUDIO TONE CONTROL

Allows the treble and bass of the speaker audio to be adjusted for the best acoustics in noisy environments. The effect is similar to adjusting the treble and bass controls on a stereo.

1. Press and hold the **CALL** key until “Setup Menu” appears, then select “Radio Setup” with the **DIAL** knob.
2. Press the **ENT** key, then select “Tone Control” with the **DIAL** knob.
3. Press the **ENT** key, then select “Bass” with the **DIAL** knob.
4. Press the **ENT** key, then rotate the **DIAL** knob to select desired audio response in the lower frequency range. Available selections are “-6” through “+6.”
5. Press the **ENT** key to store the selected setting.
6. Select “Treble” with the **DIAL** knob.
7. Press the **ENT** key, then rotate the **DIAL** knob to select desired audio response in the higher frequency range. Available selections are “-6” through “+6.”
8. Press the **ENT** key to store the selected setting.
9. Press the **CLR** key three times to return to radio operation.

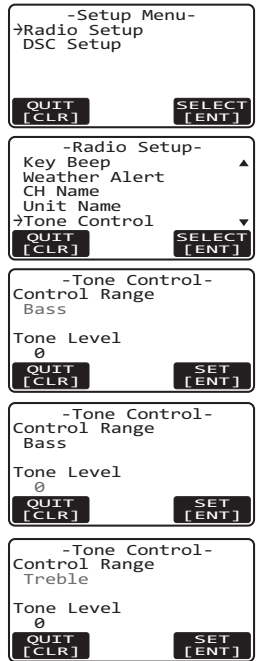

6.11 OPTIONAL RAM3 (CMP30) INSTALLATION

The **GX5500S** is capable of connecting two **RAM3 (CMP30)** Remote Access Microphones to remotely control the radio and DSC functions. In addition the **GX5500S** can operate as a full function intercom system between the **RAM3** and the radio.

1. Connect the extension cable to the remote microphone eight pin connector on the rear panel, then tighten the cable nut (see illustration at the right).

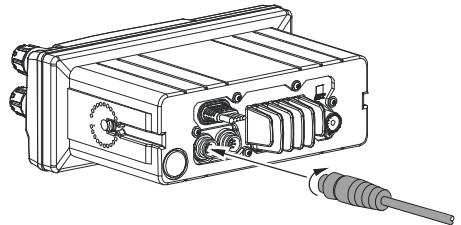

2. Install the ferrite core (supplied with the **RAM3 (CMP30)** Remote Access Microphone) to the routing cable, then snap its two halves together, per the illustration on the next page.
3. Attach the ferrite core as close as possible to the MIC plug, as shown below.
4. Finally, wind some plastic tape around each ferrite core, to prevent vibration from causing the two halves to split apart.
5. Referring to illustration below, make a 1.2" (30 mm) hole in the wall, then insert the routing cable into this hole. Connect the gasket and mount base to the routing cable connector using the nut.
6. Drill the four screw holes (approx. 2 mm) on the wall, then install the mounting base to the wall using four screws.
7. Put the rubber cap on to the nut. The installation is now complete.

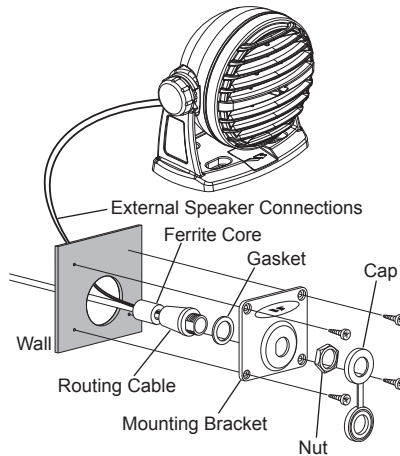
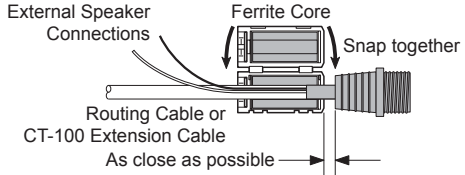











NOTE

The routing cable can be cut and spliced, however care needs to be taken when reconnecting the wires to ensure water integrity. Before cutting the cable make sure it is not plugged into the radio. After cutting you will notice there are the following wires: Yellow, Green, Brown, Purple, Blue, Gray, Red*, Shield*

* The red and shield wires are wrapped in foil. Remove the foil, and separate the red and shield wires.

6.11.1 Connecting an External Speaker to the RAM3 Mic Cable





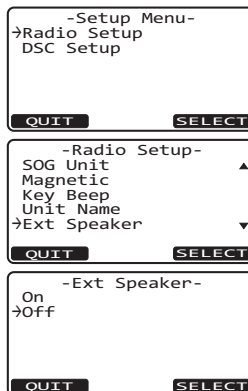





In noisy locations an optional external speaker may be connected to the white and black speaker wires on the **RAM3** routing cable (refer to previous page). The **RAM3** can drive the internal speaker or the external speaker one at a time. When connecting an external speaker, follow the procedure below to turn off the **RAM3** audio and enable the external speaker wires on the **RAM3** routing cable.

1. On the RAM3 mic, press and hold the  key until “Setup Menu” appears, then select “Radio Setup” with the  /  key.
2. Press the  key.
3. Press the  key to until “Ext Speaker” is shown and press the  key.
4. Press the  or  key to select “Off” (External speaker off) or “On” (External speaker on).
5. Press the  key to save the selection.
6. Press the  key to exit this mode.



6.11.2 External Speaker AF Selection

The “AF Select” menu allows you to set the audio output level of the **RAM3** external speaker wires (on routing cable) to a fixed level regardless of the volume level setting of the **RAM3**. This is useful when using the optional **MLS-310** amplified speaker with on/off volume control.

1. On the RAM3 mic, press and hold the  key until “Setup Menu” appears, then select “Radio Setup” with the  /  key.
2. Press the  key.
3. Press the  key to until “AF Select” is shown and press the  key.
4. Press the  or  key to select “Pr” (External speaker level is “Fixed”) or “Po” (External speaker level is “Adjustable”).
Use “Fixed” when **MLS-310** is connected.
Use “Adjustable” when **MLS-300** or other speaker without volume control is connected.
5. Press the  key to save the selection.
6. Press the  key to exit this mode.

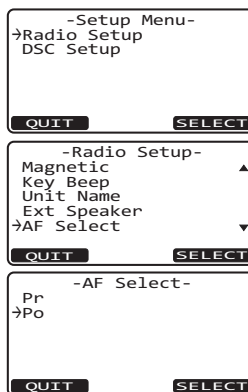

6.12 EXTRA MICROPHONE INSTALLATION

The **GX5500S** has an additional microphone connector on the rear panel that provides the same function as that on the front panel. The supplied hand microphone can be connected to the connector directly, or through the optional microphone extension kit **MEK-4** as below which allows the microphone being used remotely.

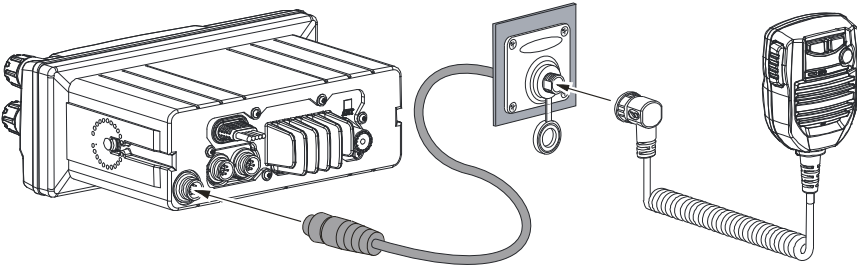

In addition the **GX5500S** is capable of connecting two hand microphones to the connectors on the front and rear panels at the same time.

7 CONTROLS AND INDICATORS

NOTE

This section defines each control of the transceiver. For operating instructions refer to section “8 BASIC OPERATION”.

7.1 FRONT PANEL

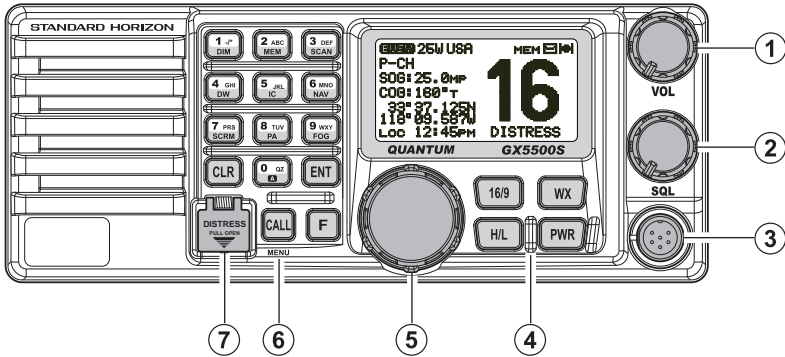

① **VOL Knob (Volume Control)**

Adjusting this control clockwise increases the audio volume level.

Secondary Use

When in PA or Fog mode, controls the listen back volume.

② **SQL Knob (Squelch Control)**

Adjusting this control clockwise sets the point at which random noise on the channel does not activate the audio circuits but a received signal does. This point is called the squelch threshold. Further adjustment of the squelch control will degrade reception of wanted transmissions.

③ **MIC Connector**

Connects to the supplied noise canceling speaker microphone.

④ **Keypad**

WX Key

Press this key immediately recalls the previously selected NOAA weather channel from any channel. Pressing this key again reverts to the previous selected working channel.

Secondary use:

Press the **WX** key while pressing and holding the **16/9** key to switch between USA, International and Canadian channel assignments.

PWR Key

Turns the transceiver on and off. To turn the transceiver on, press and hold this key until the LCD turns on. To turn it off, press and hold this key until the LCD turns off. When the power is turned on, the transceiver is set to the last selected channel.

16/9 Key

Pressing this key immediately recalls Channel 16 from any channel location. Pressing and holding this key recalls Channel 9. Pressing this key again reverts to the previous selected working channel.

Secondary use:

Press the **WX** key while pressing and holding the **16/9** key to switch between USA, International and Canadian channel assignments.

H/L Key

Press this key to toggle between 25 W (High) and 1 W (Low) power. When this key is pressed while the transceiver is on Channel 13 or 67, the power will temporarily switch from LO to HI power until the **PTT** switch of the microphone is released. The **H/L** key does not function on transmission inhibited and low power only channels.

5 **DIAL Knob (Channel Selector)**

Rotary knob used to select channels and to choose menu items (such as the DSC menu, Radio Setup and DSC Setup menu). The **▼** / **▲** keys on the microphone can also be used to select channels and menu items.

Secondary Use

- Pressing the **F** key first then pressing the **3DEF SCAN** key, and turning the **DIAL** knob while holding the **3DEF SCAN** key, you can confirm memory channels for scanning.
- Adjusts the PA output level while in PA/FOG mode.

6 **Keypad**

1-/7 DIM Key

When in radio mode, press this key to directly enter the number “1” in a channel number.

When in menu mode (such as the DSC menu and setup menu), press this key repeatedly to select either of the letters “1”, “-”, “/”, and “*”.

Secondary use





Press the **F** key first then press the **1-/7 DIM** key to access the LCD Dimmer menu. Refer to section “8.6 ADJUSTING DIMMER” for details.

2ABC MEM Key

When in radio mode, this key is used to directly enter the number “2” in a channel number.

When in menu mode (such as the DSC menu and setup menu), press this key repeatedly to select either of the letters “2”, “A”, “B”, “C”, “a”, “b”, and “c”.

Secondary use



Pressing the  key first then pressing the  key memorizes the selected channel into the transceiver scan memory for scanning. Repeating the same procedure ( → ) DELETES the channel from the scan memory. Refer to section “**8.10 SCANNING**” for details.

Key

When in radio mode, this key is used to directly enter the number “3” in a channel number.

When in menu mode (such as the DSC menu and setup menu), press this key repeatedly to select either of the letters “3”, “D”, “E”, “F”, “d”, “e”, and “f”.

Secondary use (*Depends on the transceiver version*)



Pressing the  key first then pressing the  key starts and stops the scanning of programmed channels. Refer to section “**8.10 SCANNING**” for details.

Key

When in radio mode, this key is used to directly enter the number “4” in a channel number.

When in menu mode (such as the DSC menu and setup menu), press this key repeatedly to select either of the letters “4”, “G”, “H”, “I”, “g”, “h”, and “i”.

Secondary use



Pressing the  key first then pressing the  key scans for voice communications on the priority channel and another selected channel until a signal is received on either channel (Dual Watch). Refer to section “**8.9 DUAL WATCH (TO CHANNEL 16)**” for details.

Key

When in radio mode, this key is used to directly enter the number “5” in a channel number.

When in menu mode (such as the DSC menu and setup menu), press this key repeatedly to select either of the letters “5”, “J”, “K”, “L”, “j”, “k”, and “l”.

Secondary use



Pressing the  key first then pressing the  key, when the optional **RAM3** Mic is connected, activates an intercom operation between radio and **RAM3** Mic. Refer to section “**8.12 INTERCOM OPERATION**” for details.

Key

When in radio mode, this key is used to directly enter the number “6” in a channel number.

When in menu mode (such as the DSC menu and setup menu), press this key repeatedly to select either of the letters “6”, “M”, “N”, “O”, “m”, “n”, and “o”.

Secondary use



Pressing the  key first then pressing the  key displays NAV GPS Data; Time, SOG (Speed Over Ground), and COG (Course Over Ground) on the LCD when a GPS is connected to the accessory cable of the **GX5500S**. See section “**6.6 CHECKING GPS STATUS**” for details.

Key

When in radio mode, this key is used to directly enter the number “7” in a channel number.

When in menu mode (such as the DSC menu and setup menu), press this key repeatedly to select either of the letters “7”, “P”, “R”, “S”, “p”, “r”, and “s”.

Secondary use



Pressing the  key first then pressing the  key, when the optional **CVS2500** Voice Scrambler Unit is installed, activates the operation of the Voice Scrambler function. Refer to section “**8.13 VOICE SCRAMBLER**” for details.

Key

When in radio mode, this key is used to directly enter the number “8” in a channel number.

When in menu mode (such as the DSC menu and setup menu), press this key repeatedly to select either of the letters “8”, “T”, “U”, “V”, “t”, “u”, and “v”.

Secondary use

Pressing the  key first then pressing the  key activates the operation of the 30 Watt PA function. Refer to section “**8.11 PA/FOG OPERATION**” for details.

Key

When in radio mode, this key is used to directly enter the number “9” in a channel number.

When in menu mode (such as the DSC menu and setup menu), press this key repeatedly to select either of the letters “9”, “W”, “X”, “Y”, “w”, “x”, and “y”.

Secondary use

Pressing the  key first then pressing the  key activates the

operation of the Fog Horn function. Refer to section “**8.11 PA/FOG OPERATION**” for details.

 **Key**

When in radio mode, this key is used to directly enter the number “0” in a channel number. Pressing and holding this key adds the letter “A” to the end of a channel number.

When in menu mode (such as the DSC menu and setup menu), press this key repeatedly to select either of the letters “0”, “Q”, “Z”, “q”, and “z”.

 **Key**

Press the  Key to cancel the menu selection and/or keypad entry.

 **Key**

Press the  Key to determine the menu selection and/or keypad entry.

 **Key**

Press the  key to access the DSC operation menu. The “INDIVIDUAL CALL,” “GROUP CALL,” and “ALL SHIPS CALL” functions can be accessed from the DSC operation menu.

Secondary use

Press and hold the  key to access the “Radio Setup” (refer to section “**10 RADIO SETUP**”), or “DSC Setup” menu (refer to section “**11 DSC SETUP**”).

 **Key**

Press the  key to activate the alternative key function of the keys on the keypad.

⑦  **Key**

This key is used to send a DSC distress call. Refer to section “**9.3.1 Transmitting a DSC Distress Alert**” for details.

7.2 REAR PANEL

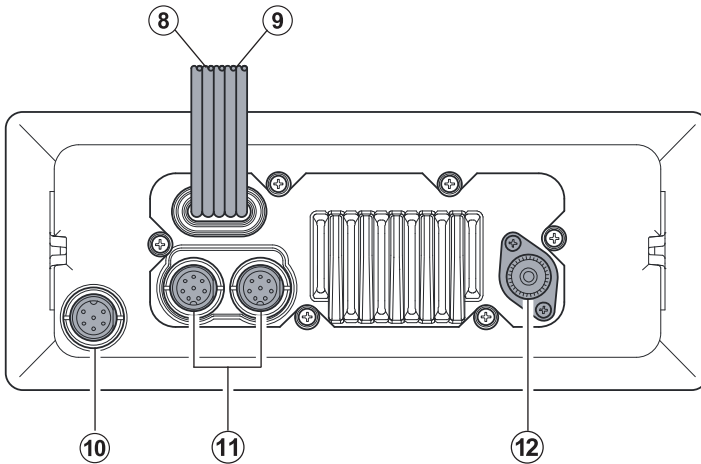

- ⑧ **Accessory Connection Cable**
Connects the **GX5500S** to a GPS, a PA/Hailer horn, and an external speaker. See section “**3 OPTIONAL ACCESSORIES**” for a list of optional STANDARD HORIZON Speakers.
- ⑨ **DC Input Cable**
Connects the radio to a DC power supply capable of delivering 11 to 16V DC.
- ⑩ **MIC Connector**
Connects the supplied hand microphone if desired. This connector provides the same function as that on the front panel and allows remote use of the microphone by using the optional **MEK-4** (microphone extension kit). Two microphones on the front and rear panels are available at the same time.
- ⑪ **RAM3 MIC Connectors**
Connects the **GX5500S** to two **RAM3** remote access microphones (**CMP30**). Refer to section “**13 RAM3 (CMP30) REMOTE MIC OPERATION**” for details.
- ⑫ **ANT (Antenna) Jack**
Connects an antenna to the transceiver. Use a marine VHF antenna with an impedance of 50 ohms.

7.3 MICROPHONE

⑬ PTT (Push-To-Talk) Switch

When in radio mode and the **PTT** switch pressed, the transmitter is enabled for voice communications to another vessel.

When an optional **RAM3** second station microphone is connected and intercom mode is selected, pressing the **PTT** switch enables voice communications from the **GX5500S** to the **RAM3** second station microphone.

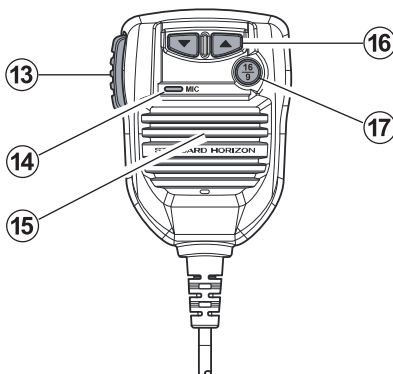

⑭ Microphone

When spoken into transmits your voice with reduction of background noise, using Clear Voice Noise Reduction Technology.



NOTE

Be sure your mouth is about 1/2 inch (1.3 cm) from the mic hole for best performance.



⑮ Microphone Speaker

The same audio heard through internal radio speaker is heard from here.

⑯ / (Down / Up) Keys

The  /  keys on the microphone are used to select channels and to choose menu items (such as the DSC menu, Radio Setup and DSC Setup menu).

⑰ Key

The  key on the microphone functions the same as the  key on the front panel of the transceiver.

Immediately recalls Channel 16 from any channel location. Pressing and holding this key recalls Channel 9. Pressing the  key again reverts to the previously selected working channel.





8 BASIC OPERATION

8.1 RECEPTION

1. After the transceiver has been installed, ensure that the power supply and antenna are properly connected.
2. Press and hold the  key until the radio turns on.
3. Rotate the **SQL** knob fully counterclockwise until "**BUSY**" is shown on the display. This state is known as "unsquelched".
4. Rotate the **VOL** knob until noise or audio from the speaker is at a comfortable level.
5. Rotate the **SQL** knob clockwise until the random noise disappears and the "**BUSY**" icon is turned off. This state is known as the "squelch threshold."
6. Rotate the **DIAL** knob to select the desired channel. Refer to section "**15 CHANNEL ASSIGNMENTS**" for available channels.

The channel number can also be input directly by using the keypad.

To select the channel 22A for example:

1. Press 
2. Press 
3. Press and hold  until "A" appears to the right of the channel number
4. Press 
7. When a message is received, adjust the volume with the **VOL** knob to the desired listening level. The "**BUSY**" indicator on the display indicates communications is being received or the radio is unsquelched.

8.2 TRANSMISSION

1. Perform steps 1 through 6 of RECEPTION.
2. Before transmitting, monitor the channel to ensure it is clear.
THIS IS AN FCC REQUIREMENT!
3. Press and hold the **PTT** (push-to-talk) switch. The "**TX**" indicator is displayed on the LCD.
4. Speak slowly and clearly into the microphone.
5. When the transmission is finished, release the **PTT** switch.

NOTE

This is a noise-canceling microphone. Position the oval slot labeled "**MIC**" within 1/2 inch (1.3 cm) from the mouth for optimum performance.

8.3 TRANSMIT TIME - OUT TIMER (TOT)

When the **PTT** switch on the microphone is held down, transmit time is limited to 5 minutes. This limits unintentional transmissions due to a stuck **PTT** switch inside the microphone. About 10 seconds before automatic transmitter shutdown, a warning beep will be heard from the speaker(s). The transceiver will automatically go to receive mode, even if the **PTT** switch is continually held down. Before transmitting again, the **PTT** switch must first be released and then pressed again.

8.4 SIMPLEX/DUPLEX CHANNEL USE

Refer to section “**15 CHANNEL ASSIGNMENTS**” for instructions on use of simplex and duplex channels.

NOTE

All channels are factory-programmed in accordance with FCC (USA), Industry Canada, and International regulations. Mode of operation cannot be altered from simplex to duplex or vice-versa.

8.5 DISPLAYING SOG AND COG INFORMATION

The transceiver has the ability to display the time, date, SOG (Speed Over Ground) and COG (Course Over Ground), as well as the vessel's position (latitude and longitude), when connected to a GPS receiver.

1. Press the **[F]** key followed by the **[GMRG NAV]** key to display SOG and COG information.
2. To hide SOG and COG information, press the **[F]** key followed by the **[GMRG NAV]** key again.

8.6 ADJUSTING DIMMER

The transceiver allows setting up the backlight intensity or to turn it off.

1. Press the **[F]** key followed by the **[1 → DIM]** key to enable the setting up of the backlight intensity.
2. Rotate the **DIAL** knob to select the desired backlight intensity.
3. Press the **[CLR]** key to return to radio operation.

8.7 USA, CANADA, AND INTERNATIONAL MODE

To change the channel assignment from USA to Canada or International:

1. To change the channel assignments, hold the **16/9** key and press the **WX** key. The mode changes from USA to International then Canadian with each press of the **WX** key.
2. “**USA**” will be displayed on the LCD for USA mode, “**INTL**” for International mode, and “**CAN**” for Canadian mode.
3. Refer to the VHF MARINE CHANNEL CHART (page 108) for allocated channels in each mode.

8.8 NOAA WEATHER CHANNELS

1. To receive a NOAA weather channel, press the **WX** key from any channel. The transceiver will go to the last selected weather channel and the “**WX**” icon appears on the display.
2. Rotate the **DIAL** knob to select a different NOAA weather channel.
3. To exit from the NOAA weather channels, press the **WX** key. The transceiver returns to the channel it was on prior to a weather channel and the “**WX**” icon disappears on the display.

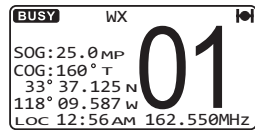

8.8.1 NOAA Weather Alert

In the event of extreme weather disturbances, such as storms and hurricanes, the NOAA (National Oceanic and Atmospheric Administration) sends a weather alert accompanied by a 1050 Hz tone and subsequent weather report on one of the NOAA weather channels.

The **GX5500S** can receive weather alerts when on a weather channel and on the last selected weather channel during scanning modes or while on another channel.

When an alert is received on a NOAA weather channel, scanning will stop and the transceiver will emit a loud beep to alert the user of a NOAA broadcast. Press any key to stop the alert and receive the weather report.

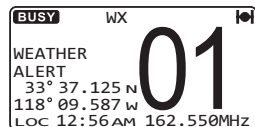

To disable the weather alert function, refer to section “**10.10 WEATHER ALERT**”.

NOTE

- If a key is not pressed the alert will sound for 5 minutes and then the weather report will be received.
- While listening to a weather channel, the radio can decode a weather alert and sound an alarm.

8.8.2 NOAA Weather Alert Testing

NOAA tests the alert system ever Wednesday between 11AM and 1PM. To test the NOAA weather feature of the **GX5500S**, on Wednesday between 11AM and 1PM, setup as in section “**8.8.1 NOAA Weather Alert**” and confirm the alert is heard.

8.9 DUAL WATCH (TO CHANNEL 16)

Dual watch is used to scan two channels for communications. One channel is a normal VHF channel and the other is the priority, Channel 16. When a signal is received on the normal channel the radio briefly switches between the normal channel and Channel 16 to look for a transmission. If the radio receives communications on Channel 16 the radio stops and listens to Channel 16 until communication ends and then starts dual watch scan again.

1. Adjust the **SQL** knob until the background noise disappears.
2. Select the channel you wish to dual watch to the priority Channel 16.
3. Press the **[F]** key, then press the **[4 GHI DW]** key.
The display show “DW-16” and will scan between CH16 and the channel that was selected in step 2. If a transmission is received on the channel selected in step 2, the **GX5500S** will dual watch to CH16.
4. To stop dual watch, press the **[F]** key, then press the **[4 GHI DW]** key again.

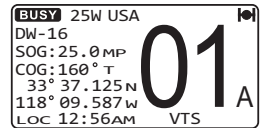

NOTE

The priority channel may be changed from CH16 to another channel. Refer to section “**10.6 PRIORITY CHANNEL**”.

8.10 SCANNING

Allows you to select the scan type from memory scan or priority scan. “Memory Scan” scans the channels that were programmed into memory. “Priority Scan” scans the channels programmed in memory with the priority channel.

8.10.1 Scan Type Selection

1. Press and hold the **[CALL]** key until “Setup Menu” appears.
2. Rotate the **DIAL** knob to select “Radio Setup”.
3. Press the **[ENT]** key, then rotate the **DIAL** knob to select “SCAN Type”.
4. Press the **[ENT]** key.
5. Rotate the **DIAL** knob to select “Priority SCAN” or “Memory SCAN”.
6. Press the **[ENT]** key to store the selected setting.
7. Press the **[CLR]** key twice to return to radio operation.

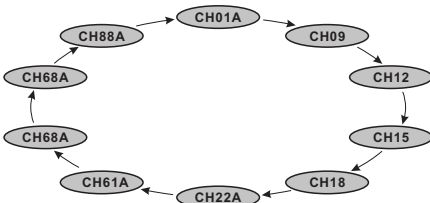
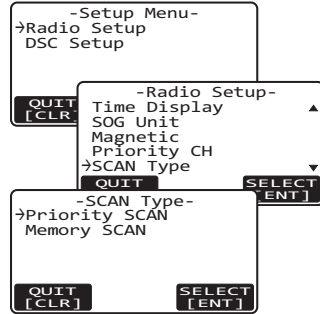

MEMORY SCAN (M-SCAN)

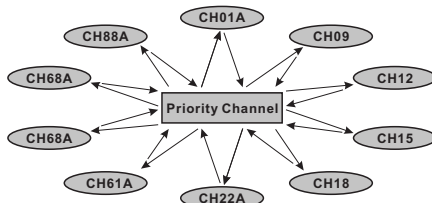

PRIORITY SCAN (P-SCAN)

8.10.2 Scan Channel Memory Programming

1. Adjust the **SQL** knob until the background noise disappears.
2. Select a desired channel with the **DIAL** knob or keypad.
3. Press the **[F]** key, then press the **[2ABC MEM]** key. “MEM” icon appears on the display, which indicates the channel has been programmed into the transceiver’s memory.
4. Repeat the steps 2 and 3 for all the desired channel to be scanned.
5. To DELETE a channel from the transceiver’s memory, select the channel, press the **[F]** key, then press the **[2ABC MEM]** key. “MEM” icon disappears from the display.

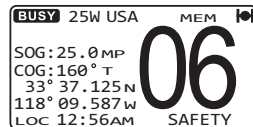

8.10.3 Memory Scanning (M-SCAN)

1. Set the scan type of the transceiver to “Memory Scan” in the setup mode.
2. Adjust the **SQL** knob until the background noise disappears.
3. Press **[F]** key, then press the **[3DEF SCAN]** key. “M-SCAN” appears on the display. Scanning will proceed from the lowest to the highest programmed channel number and preset channel (described in the next chapter) and will stop on a channel when a transmission is received.
4. The channel number will blink during reception.
5. To stop scanning, press the **[CLR]**, **[16/9]**, or **[WX]** key.

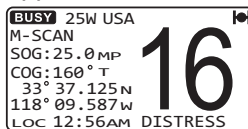

8.10.4 Priority Scanning (P-SCAN)

By default, Channel 16 is set as the priority channel. You may change the priority channel to the desired channel from Channel 16 through the setup mode, refer to section “10.6 PRIORITY CHANNEL”.

1. Set the scan type of the transceiver to “Priority Scan” in the setup mode.
2. Adjust the **SQL** knob until the background noise disappears.
3. Press **[F]** key, then press the **[3DEF SCAN]** key. “P-SCAN” appears on the display. Scanning will proceed from the lowest to the highest programmed channel number and preset channel (described in the next chapter) and will stop on a channel when a transmission is received.
4. To stop scanning, press the **[CLR]**, **[16/9]**, or **[WX]** key.

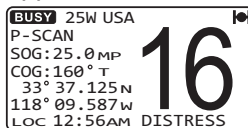

8.11 PA/FOG OPERATION

The **GX5500S** has a 30W hailer built-in and can be used with any 4 Ohm PA/Hailer horn. Standard Horizon offers two PA/Hailer horns, the **220SW** (5" round 30 Watt PA/Hailer horn) and the **240SW** (5" x 8" rectangular 40 Watt PA/Hailer horn). When the **GX5500S** is in PA/HAILER mode the PA/Hailer horn listens back (acts as a microphone and provides two-way communications through the PA/Hailer horn to the main radio).

NOTE

When in the PA/HAILER or FOG HORN mode, the **GX5500S** will continue to receive DSC calls and communications on the last selected working channel prior to entering the PA/HAILER or FOG HORN mode.

PA/HAILER mode:

This mode allows the transceiver to be used as a powerful loud hailer when an optional STANDARD HORIZON **220SW** or **240SW** PA/Hailer horn is installed. The PA/HAILER mode has a listen-back feature which provides two way communication through the PA/Hailer horn.

FOG HORN mode:

Automatic signaling is transmitted through the PA/Hailer horn. When the fog horn, bells or whistle signal is not being outputted the **GX5500S** listens back through the connected PA/Hailer horn.

8.11.1 Operating the PA/HAILER mode

1. Press **[F]** key, then press the **[STUV PA]** key to activate the PA/HAILER mode.
2. Press the **PTT** switch to speak through the PA/Hailer horn.

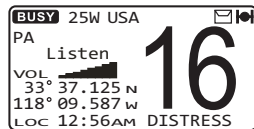

Rotate the **DIAL** knob to control the AF output level. The AF output level can be set from 0 to 30 watts.

3. To listen back, rotate the **VOL** knob.
4. To exit the PA/HAILER mode, press the **[CLR]** key.

8.11.2 Operating the FOG HORN mode

The user can select the type of horn from “Underway”, “Stop”, “Sail”, “Tow”, “Aground”, “Anchor”, “Horn”, and “Siren”.

1. Press **[F]** key, then press the **[Swxy FOG]** key to activate the FOG HORN mode.
2. Rotate the **DIAL** knob to select one of the eight functions described above.
3. Press the **[ENT]** key.
4. On the “Horn” and “Siren” modes, press the **PTT** switch to activate the tone through the PA/Hailer horn.

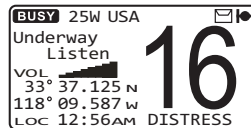

Rotate the **DIAL** knob to control the AF output level. The AF output level can be set from 0 to 30 watts.

5. To listen back, rotate the **VOL** knob.
6. To exit the FOG HORN mode, press the **[CLR]** key.

8.11.3 Fog Signal Timing Chart

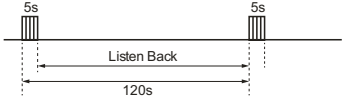
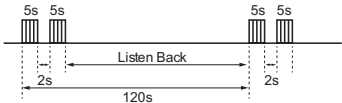
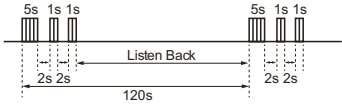
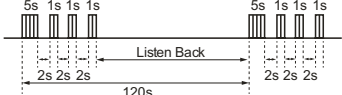
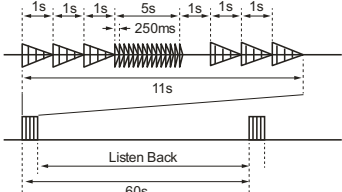
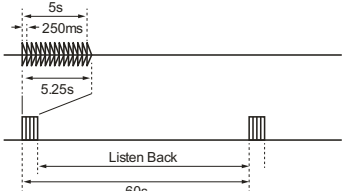
TYPE	PATTERN	USAGE
UNDERWAY	<p>One 5-second blasts every 120 seconds.</p> 	<p>Motor vessel underway and making way.</p>
STOP	<p>Two 5-second blasts (separated by 2 seconds) every 120 seconds.</p> 	<p>Motor vessel underway but stopped (not making way).</p>
SAIL	<p>One 5-second blasts followed by two 1-second blasts (separated by 2 seconds) every 120 seconds.</p> 	<p>Sailing vessel underway, fishing vessel (underway or anchored), vessel not under command, a vessel restricted in her ability to maneuver (underway or at anchor), or a vessel towing or pushing another ahead.</p>
TOW	<p>One 5-second blasts followed by three 1-second blasts (separated by 2 seconds) every 120 seconds.</p> 	<p>Vessel under tow (manned).</p>
AGROUND	<p>One 11-second rings every 60 seconds.</p> 	<p>Vessel is aground.</p>
ANCHOR	<p>One 5-second rings every 60 seconds.</p> 	<p>Vessel is at anchor.</p>

8.12 INTERCOM OPERATION

An optional **CMP30** remote access microphone must be connected to perform intercom functions between the radio and the **RAM3**.

8.12.1 Communication

1. Press **[F]** key, then press the **[5 JKL IC]** key to enable the intercom mode.
2. When two **RAM3 (CMP30)** microphones are connected, turn the **DIAL** knob to select the unit to be called (“RAM1”, “RAM2”, “ALL”), and then press the **[ENT]** key.
3. When the intercom mode is enabled, “Intercom” is displayed on the radio and the **RAM3 (CMP30)** microphone.

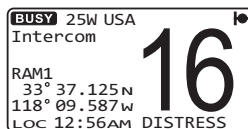

4. Press the **PTT** switch on the microphone. “Talk” will be shown on the display.

Note: A warning beep will be heard if the **PTT** switches of

the **GX5500S**'s hand microphone and **RAM3 (CMP30)** microphone are pushed simultaneously.



(GX5500S's PTT switch is pressed)

5. Speak slowly and clearly into the microphone, hold the microphone about 1/2 inch away from your mouth.



(RAM3's PTT switch is pressed)

6. When finished, release the **PTT** switch.
7. Press the **[CLR]** key to exit the intercom mode and revert to the radio mode.

8.12.2 Calling

Pressing and holding the **[5 JKL IC]** key when in the intercom mode on either the radio or **RAM3 (CMP30)** microphone will produce a calling beep to the other station.

8.13 VOICE SCRAMBLER

If privacy of communications is desired, a **CVS2500** 4-code voice scrambler (VS) can be installed in the transceiver. Contact your Dealer to have a **CVS2500** installed.

1. Turn the **DIAL** knob to select the channel to be scrambled.
Note: Channel 16 and 70 can not operate the voice scrambler.
2. Press the **[F]** key followed by the **[7 PRS SCRM]** key to activate voice scrambler. "VS" and scrambler number ("0," "1," "2," or "3") will appear on the LCD.
3. Press the **[F]** key, then press and hold the **[7 PRS SCRM]** key until "Scrambler" menu appears.
4. Turn the **DIAL** knob to change the scrambler code. The scrambler code can be set from "0" to "3."
5. Press the **[ENT]** key to save the scrambler code and return to radio operation mode (with voice scrambler).
6. Monitor the channel before transmitting.
7. To disable the voice scrambler, press the **[F]** key followed by the **[7 PRS SCRM]** key again. "VS" and scrambler number ("0," "1," "2," or "3") disappear from the LCD.

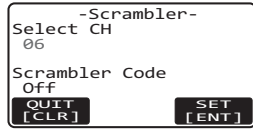
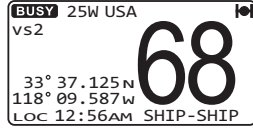

8.14 WIRELESS OPERATION

The optional **BH-2A**, a Bluetooth headset, allows you to listen and talk without hand microphones when you are away from the transceiver. The Bluetooth adapter unit **BU-1** must be installed in the transceiver when using the **BH-2A**. Contact your Dealer to have a **BU-1** installed.

When the **BH-2A** is correctly recognized by the transceiver, the "📶" icon will appear on the display of the transceiver.

See also the section "**12 BLUETOOTH SETUP**" for details.

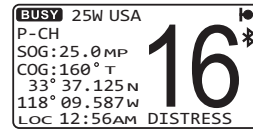

9 DIGITAL SELECTIVE CALLING

9.1 GENERAL

WARNING

The **GX5500S** is designed to generate digital maritime distress and safety calls to facilitate search and rescue. To be effective as a safety device, this equipment must be used only within communication range of a shore-based VHF marine channel 70 distress and safety watch system. The range of signal may vary, however under normal conditions should be approximately 20 nautical miles.

Digital Selective Calling (DSC) is a semi-automated method of establishing a radio call, it has been designated by the International Maritime Organization (IMO) as an international standard for establishing VHF, MF and HF radio calls. It has also been designated as part of the Global Maritime Distress and Safety System (GMDSS).

Digital Selective Calling allows mariners to instantly send a distress call with GPS position (when connected to the transceiver) to the US Coast Guard and other vessels within range of the transmission. DSC will also allow mariners to initiate or receive Distress, Urgency, Safety, Routine, Position Request, Position Report, Automatic Position Polling and Group calls to or from another vessel equipped with a DSC transceiver.

NOTE

A DSC Warning sticker is included with the **GX5500S**. To comply with FCC regulations this sticker must be mounted in a location that can be easily viewed from the location of the **GX5500S**.

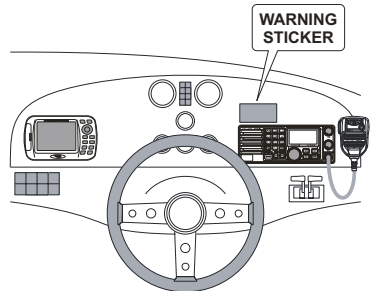

9.2 MARITIME MOBILE SERVICE IDENTITY (MMSI)

9.2.1 What is an MMSI?

An MMSI is a nine digit number used on marine transceivers capable of using Digital Selective Calling (DSC). This number is used like a telephone number to selectively call other vessels.

THIS NUMBER MUST BE PROGRAMMED INTO THE RADIO TO OPERATE DSC FUNCTIONS.

How can I obtain an MMSI assignment?

In the USA, visit the following websites to register:

<http://www.boatus.com/mmsi/>

http://seatow.com/boating_safety/mmsi.asp

<http://www.usps.org/php/mmsi/rules.php>

In Canada, visit

<http://www.ic.gc.ca/epic/site/smt-gst.nsf/en/sf01032e.html>

9.2.2 Programming the MMSI

WARNING

The MMSI can be inputted only once. Therefore **please be careful not to input an incorrect MMSI number.** If you need to change the MMSI number after it has been entered, the radio will have to be returned to Factory Service. Refer to section “**14.2 FACTORY SERVICE.**”

1. Press and hold the **[CALL]** key until “Setup Menu” appears.
2. Rotate the **DIAL** knob to select “DSC Setup” menu, then press the **[ENT]** key.
3. Rotate the **DIAL** knob to select “User MMSI”.
4. Press the **[ENT]** key. (To cancel, press the **[CLR]** key.)
5. Press an appropriate number key on the keypad to select the first number of your MMSI.
6. Repeat step 5 to set your MMSI number (nine digits).
7. If a mistake was made entering in the MMSI number, press the **[H/L]** key until the wrong digit is selected, then press an appropriate number key to correct the entry.
8. When finished programming the MMSI number, press and hold the **[ENT]** key. The radio will ask you to input the MMSI number again. Use steps 5 through 7 above.

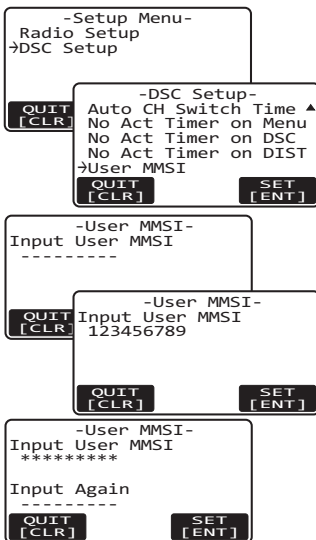

9. After the second number has been input, press and hold the **[ENT]** to store the MMSI.
10. Press the **[ENT]** key to return to the setup menu.
11. Press the **[CLR]** key twice to return to radio operation.

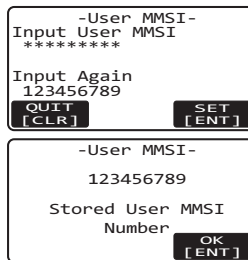

NOTE

To view your MMSI after programming to ensure it is correct, perform steps 1 through 4. Look that the MMSI number shown on the display is correct.

9.3 DSC DISTRESS ALERT

The **GX5500S** is capable of transmitting and receiving DSC distress messages with your vessels position. See also the section “**6.5 ACCESSORY CABLES.**”

9.3.1 Transmitting a DSC Distress Alert

NOTE

To be able to transmit a DSC distress alert an MMSI number must be programmed (refer to section “**9.2.2 Programming the MMSI**”).

9.3.1.1 Basic Operation

1. Lift the red spring loaded DISTRESS cover, and press and hold the **DISTRESS** key. The “DISTRESS ALERT” menu will appear on the display. The radio will count down (3-2-1) and then transmit the distress alert. The backlight of the display and keypad flashes while the radios display is counting down.
2. When the distress signal is sent, the transceiver watches for a transmission between CH16 and CH70 until an acknowledgment signal is received.
3. If no acknowledgment is received, the distress call is repeated in 4 minute intervals until a DSC acknowledgment is received.

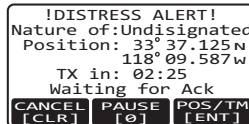
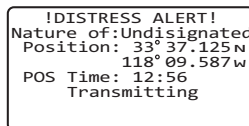
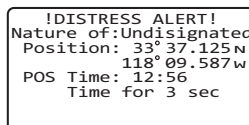

4. When a DSC distress acknowledgment is received, a distress alarm sounds and channel 16 is automatically selected. The display shows the MMSI of the ship responding to your distress.
RECEIVED ACK: acknowledgment signal is received.
RECEIVED RLY: relay signal is received from another vessel or coast station.
5. Press the **PTT** switch and state your name, vessel name, number of persons on board and the distress situation, then say “over” and wait for a reply from the acknowledging ship.
6. To momentarily turn off the distress alarm until the radio retransmits the distress call, press the **16/9** key.

9.3.1.2 Transmitting a DSC Distress Alert with Nature of Distress

The **GX5500S** is capable of transmitting a DSC distress alert with the following “Nature of Distress” categories you may have:

Undesignated, Fire, Flooding, Collision, Grounding, Capsizing, Sinking, Adrift, Abandoning, Piracy, MOB

1. Press the **CALL** key. The “DSC Menu” will appear.
2. Rotate the **DIAL** knob to select “Distress Alert MSG”.
3. Press the **ENT** key. (To cancel, press the **CLR** key.) The “DISTRESS ALERT MSG” menu will appear on the display.
4. Press the **ENT** key.
5. Rotate the **DIAL** knob to select the desired nature of distress category.
Nature of distress categories: Fire, Flood, Collision, Grounding, Capsizing, Sinking, Adrift, Abandoning, Piracy, and MOB.
6. Press the **ENT** key.
7. Press and hold the **DISTRESS** key until a distress alert is transmitted.
8. Perform the steps 1 through 6 of the basic operation described in the previous section.

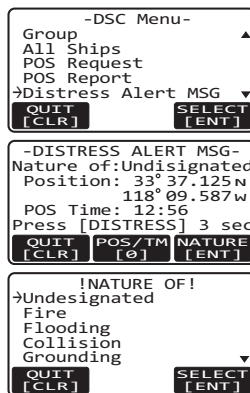

9.3.1.3 Transmitting a DSC Distress Alert by Manually Entering a Position

The **GX5500S** allows you to manually enter a latitude/longitude of your vessel to be able to transmit a DSC distress alert.

1. Press the **[CALL]** key. The “DSC Menu” will appear.
2. Rotate the **DIAL** knob to select “Distress Alert MSG”.
3. Press the **[ENT]** key. (To cancel, press the **[CLR]** key.) The “DISTRESS ALERT MSG” menu will appear on the display.
4. Press the **[0.2 A]** key.
5. Enter the latitude and longitude of your vessel with the keypad. Press the **[6MNO NAV]** key to enter “N” (north), the **[7PRS SCRM]** key to enter “S” (south), the **[3DEF SCAN]** key to enter “E” (east), or the **[9WXYZ FOG]** key to enter “W” (west), then press the **[ENT]** key.

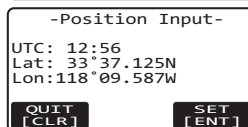
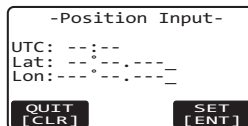
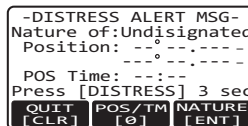

You may backspace the cursor by pressing the **[H/L]** key if you make a mistake.

6. Enter the UTC time in the 24-hour format with the keypad, and press the **[ENT]** key.
7. When you have completed your selection, press and hold the **[ENT]** key to save the setting.
8. Press and hold the **[DISTRESS]** key until a distress alert is transmitted.
9. Perform the steps 1 through 6 of the basic operation described in the previous section.



9.3.1.4 Pausing a DSC Distress Call

After a DSC distress call is transmitted, the call is repeated every 4 minutes until the call is canceled by the user or until the radio is turned off and on again. The **GX5500S** has provision to suspend (pause) the retransmitting of the distress call by the procedure below.

1. After the distress call is transmitted, the radio will show the display as in the right.
Looking at this display you will notice “TX in: 02:25” that is the time when the radio will re-transmit the DSC distress call.
2. To suspend re-transmitting the DSC distress call, press the  key.
3. To resume counting down to transmit the DSC distress call, press the  key.

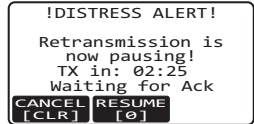
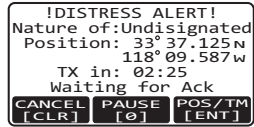

9.3.1.5 Canceling a DSC Distress Call

If a DSC distress call was sent by error the **GX5500S** allows you to send a message to other vessels to cancel the distress call that was made.

Press the  key, then press the  key.

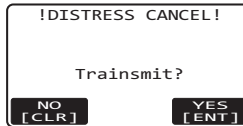
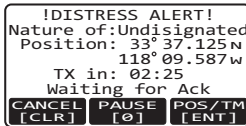

9.3.2 Receiving a DSC Distress Call

1. When a DSC distress call is received, an emergency alarm sounds.
2. Press any key to stop the alarm.
3. The display shows the position of the vessel in distress.
4. To ACCEPT the DSC distress call, press the **[ENT]** key. The radio switches immediately to Channel 16.

```
Received DISTRESS
Name:
ID:345678901
Since:01:03
Not Acknowledged
-DISTRESS INFO-
QUIT [CLR] PAUSE [O] ACCEPT [ENT]
```

```
Received DISTRESS
Name:
ID:345678901
Since:01:07
Not Acknowledged
-DISTRESS INFO-
QUIT [CLR]
```

Note: If a key is not pressed for 30 seconds (by default; refer to section “11.8 AUTO CHANNEL SWITCH TIME”) or longer the radio will automatically select Channel 16.

To SUSPEND the switching of the channel, press the **[0.2]** key.

To EXIT, press the **[CLR]** key. The radio reverts to the previous working channel.

5. Rotate the **DIAL** knob to show all the information of the vessel in distress.

```
Received DISTRESS
-DISTRESS INFO-
Nature of:Undesignated
DIST ID:345678901
Position: 33°39.220N
118°10.560W
QUIT [CLR]
```

NOTE

You must continue monitoring Channel 16 as a coast station may require assistance in the rescue attempt.

NOTE

When there is an unread distress alert, “” icon will appear on the display. You may review the unread distress alert from the DSC log, refer to section “9.12.1 Reviewing Logged DSC Distress Calls.”

9.4 ALL SHIPS CALL

The all ships call function allows contact to be established with DSC equipped vessels without having their MMSI in the individual calling directory. Also, priority for the call can be designated as “Urgency” or “Safety”.

URGENCY Call: This type of call is used when a vessel may not truly be in distress, but has a potential problem that may lead to a distress situation. This call is the same as saying “PAN PAN, PAN PAN, PAN PAN” on Channel 16.

SAFETY Call: This type of call is used to transmit boating safety information to other vessels. This message usually contains information about an overdue boat, debris in the water, loss of a navigation aid or an important meteorological message. This call is the same as saying “Securite, Securite, Securite.”

9.4.1 Transmitting an All Ships Call

1. Press the **CALL** key. The “DSC Menu” will appear.
2. Rotate the **DIAL** knob to select “All Ships”.
3. Press the **ENT** key. (To cancel, press the **CLR** key.)
4. Rotate the **DIAL** knob to select the nature of call (“Safety” or “Urgency”), then press the **ENT** key.
5. Rotate the **DIAL** knob to select the operating channel you want to communicate on, then press the **ENT** key.
6. Press the **ENT** key to transmit the selected type of all ships DSC call.
7. After the all ships call is transmitted, the transceiver will switch to the selected channel.
8. Listen to the channel to make sure it is not busy, then press the microphone’s **PTT** switch and say “PAN PAN, PAN PAN, PAN PAN” or “Securite, Securite, Securite” depending on the priority of the call and state your message.
9. Press the **CLR** key to exit the all ships call menu.

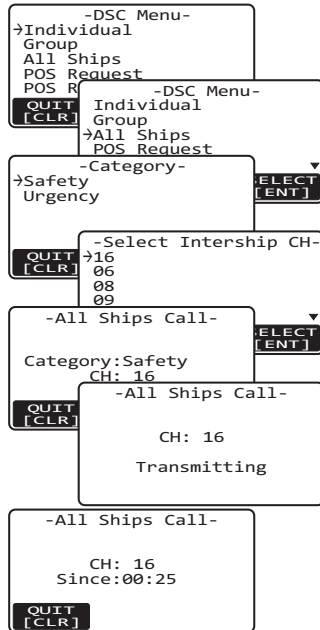

9.4.2 Receiving an All Ships Call

1. When an all ships call is received, an emergency alarm will sound.

The display shows the MMSI of the vessel transmitting the all ships call and the radio will change to the requested channel after 10 seconds.

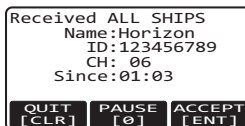

2. Press any key to stop the alarm.
3. Monitor the requested channel until the all ships voice communication is completed.
4. To ACCEPT the all ships call, press the **[ENT]** key. The radio immediately switches to the requested channel.

Note: If a key is not pressed for 30 seconds or longer the radio will automatically switch to the requested channel.

To SUSPEND the switching of the channel, press the **[002]** key.

To EXIT, press the **[CLR]** key. The radio reverts to the previous working channel.

NOTE

When there is an unread all ships call, “” icon will appear on the display. You may review the unread all ships call from the DSC log, refer to section “**9.12.2 Reviewing Other Logged Calls.**”

9.5 INDIVIDUAL CALL

This feature allows the **GX5500S** to contact another vessel with a DSC VHF radio and automatically switch the receiving radio to a desired communications channel. This feature is similar to calling a vessel on CH16 and requesting to go to another channel (switching to the channel is private between the two stations). Up to 80 Individual contacts may be programmed.

9.5.1 Setting up the Individual / Position Call Directory

The **GX5500S** has a DSC directory that allows you to store a vessel's or person's name and the MMSI (Maritime Mobile Service Identity Number) number associated with vessels you wish to transmit individual calls, auto polling calls, position requests, and position reports.

To transmit an individual call you must program this directory with information of the persons you wish to call, similar to a cellular phones telephone directory.

1. Press and hold the **[CALL]** key until "Setup Menu" appears.
2. Rotate the **DIAL** knob to select "DSC Setup" menu.
3. Press the **[ENT]** key, then select "Individual Directory" with the **DIAL** knob.
4. Press the **[ENT]** key.
5. Select "Add" with the **DIAL** knob, then press the **[ENT]** key.
6. Press an appropriate key on the keypad to enter the first letter of the name of the vessel or person you want to reference in the directory.
7. Press the **[ENT]** key to store the first letter in the name and step to the next letter to the right.
8. Repeat the steps 6 and 7 until the name is complete. The name can consist of up to eleven characters, if you do not use all eleven characters press the **[ENT]** key to move to the next space. This method can also be used to enter a blank space in the name. If a mistake was made entering in the name repeatedly press the **[H/L]** key until the wrong character is selected, then press an appropriate key to correct the entry.

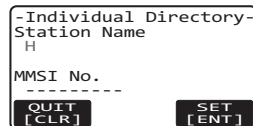
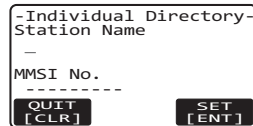
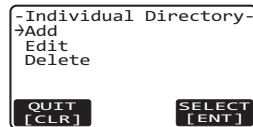
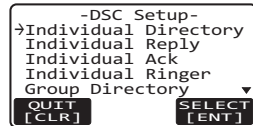

9. After the eleventh letter or space has been entered, press and hold the **[ENT]** key to advance to the MMSI number entry.
10. Press an appropriate number key on the keypad to enter the first digit of the MMSI number.
11. Repeat the steps 10 until nine digits of the number is complete. If a mistake was made entering in the number repeatedly press the **[H/L]** key until the wrong character is selected, then press an appropriate number key to correct the entry.
12. To store the data entered, press and hold the **[ENT]** key.
13. To enter another individual address, repeat steps 5 through 12.
14. Press the **[CLR]** key three times to return to radio operation.

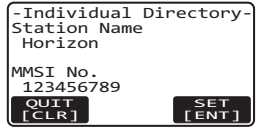
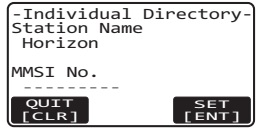

9.5.2 Setting up the Individual Call Reply

This menu item sets up the radio to automatically (default setting) or manually respond to a DSC individual call requesting you to switch to a working channel for voice communications. When “Manual” is selected the MMSI of the calling vessel is shown allowing you to see who is calling. This function is similar to caller ID on a cellular phone.

1. Press and hold the **[CALL]** key until “Setup Menu” appears.
2. Rotate the **DIAL** knob to select “DSC Setup” menu.
3. Press the **[ENT]** key, then select “Individual Reply” with the **DIAL** knob.
4. Press the **[ENT]** key.
5. Rotate the **DIAL** knob to select “Automatic” or “Manual”.
6. Press the **[ENT]** key to store the selected setting.
7. Press the **[CLR]** key twice to return to radio operation.

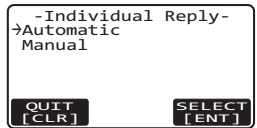
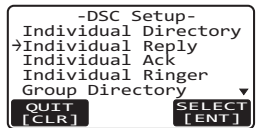
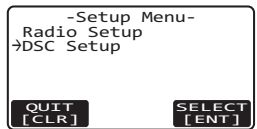

9.5.3 Setting up the Individual Call Acknowledgment

When the individual reply setting (described in the previous section) is set to “AUTOMATIC”, the **GX5500S** can be setup to reply “Able” (default) or “Unable” to a received individual call. When “Unable” is selected the **GX5500S** will transmit an “Unable” reply to the calling station to inform them you are away from your radio.

1. Press and hold the **[CALL]** key until “Setup Menu” appears.
2. Rotate the **DIAL** knob to select “DSC Setup” menu.
3. Press the **[ENT]** key, then select “Individual ACK” with the **DIAL** knob.
4. Press the **[ENT]** key.
5. Rotate the **DIAL** knob to select “Able to comply” or “Unable”.
6. Press the **[ENT]** key to store the selected setting, then press the **[CLR]** key twice to return to radio operation.

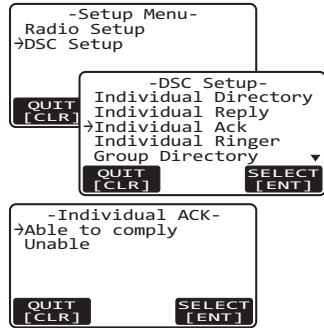

9.5.4 Transmitting an Individual Call

This feature allows you to contact another vessel with a DSC radio. This feature is similar to calling a vessel on CH16 and requesting to go to another channel.

9.5.4.1 Individual Call using the Individual/Position Call Directory

1. Press the **[CALL]** key. The “DSC Menu” will appear.
2. Rotate the **DIAL** knob to select “Individual”. (To cancel, press the **[CLR]** key.)
3. Press the **[ENT]** key. The individual directory will appear.
4. Rotate the **DIAL** knob to select an individual you want to contact.
5. Press the **[ENT]** key, then rotate the **DIAL** knob to select the operating channel you want to communicate on, then press the **[ENT]** key.
6. Press the **[ENT]** key to transmit the individual DSC signal.
7. When an individual call acknowledgment is received, press the **[CLR]** key to automatically change to the channel selected in step 5 above and a ringing tone sounds.
8. Listen to the channel to make sure it is not busy, then press the microphone’s **PTT** switch and talk into the microphone to the other vessel.

```
-DSC Menu-
→Individual
  Group
  All Ships
  POS Request
  POS Report
  [QUIT [CLR]] [SELECT [ENT]]
```

```
-Individual Call-
Manual
→Horizon
  YAESU
  Standard
  Bob
  [QUIT [CLR]] [SELECT [ENT]]
```

```
-Select Intership CH-
→06
  08
  09
  10
  13
  [QUIT [CLR]]
```

```
-Individual Call-
Name:Horizon
ID:123456789
Category:Routine
CH: 06
Transmit?
  [QUIT [CLR]] [YES [ENT]]
```

```
-Individual Call-
Name:Horizon
ID:123456789
CH: 06
  [QUIT [CLR]]
```

```
-Individual Call-
Name:Horizon
ID:123456789
CH: 06
Since:01:03
CONNECTED
  [QUIT [CLR]]
```

9.5.4.2 Individual Call by Manually Entering a MMSI

You may enter an MMSI number manually to contact a vessel without storing the MMSI in the individual/position call directory.

1. Press the **[CALL]** key. The “DSC Menu” will appear.
2. Confirm “Individual” is selected. (To cancel, press the **[CLR]** key.)
3. Press the **[ENT]** key. The individual directory will appear.
4. Rotate the **DIAL** knob to select “Manual”, then press the **[ENT]** key.
5. Press an appropriate number key on the keypad to select the first number of the MMSI which you want to contact.
6. Repeat step 5 to set the MMSI number (nine digits).
7. If a mistake was made entering in the MMSI number, repeatedly press the **[HL]** key until the wrong digit is selected, then press an appropriate number key to correct the entry.
8. When finished entering the MMSI number, press and hold the **[ENT]** key.
9. Rotate the **DIAL** knob to select the operating channel you want to communicate on, then press the **[ENT]** key.
10. Press the **[ENT]** key to transmit the individual DSC signal.
11. When an individual call acknowledgment is received, press the **[CLR]** key to automatically change to the channel which is selected on step 5 above and a ringing tone sounds.
12. Listen to the channel to make sure it is not busy, then press the microphone's **PTT** switch and talk into the microphone to the other vessel.

```
-DSC Menu-
->Individual
Group
All Ships
POS Request
POS Report
QUIT [CLR] SELECT [ENT]
```

```
-Individual Call-
->Manual
Horizon
YAESU
Standard
Bob
QUIT [CLR] SELECT [ENT]
```

```
-Individual Call-
Input MMSI
ID:-----
QUIT [CLR] SELECT [ENT]
```

```
-Individual Call-
Input MMSI
ID:345678901
QUIT [CLR] SELECT [ENT]
```

```
-Select Intership CH-
->06
08
09
10
13
QUIT [CLR] SELECT [ENT]
```

```
-Individual Call-
Name:
ID:345678901
Category:Routine
CH: 06
Transmit?
QUIT [CLR] YES [ENT]
```

```
-Individual Call-
Name:
ID:345678901
CH: 06
Since:01:03
Waiting for ACK
QUIT [CLR] RESEND [ENT]
```

```
-Individual Call-
Name:
ID:345678901
CH: 06
Since:01:03
CONNECTED
QUIT [CLR]
```



9.5.5 Receiving an Individual Call

When an individual DSC call is received, the radio will automatically respond (Default setting) to the calling ship, and switch to the requested channel for voice communications. Refer to section “9.5.2 Setting up the Individual Call Reply” to change the reply to “Manual” if you want to see who is calling before replying to the call.

Automatic reply:

1. When an individual call is received, an individual call ringing alarm sounds.

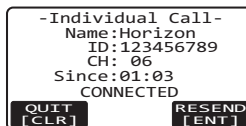
The radio automatically switches to the requested channel. The display shows the MMSI of the vessel calling.



2. Press any key to stop the alarm.
3. Press the **[CLR]** key to return to radio operation.
4. Press the microphone's **PTT** switch and talk into the microphone to the other vessel.

Manual reply:

1. When an individual call is received, an individual call ringing alarm sounds.

The display shows the MMSI of the vessel calling.

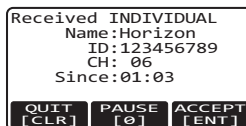

2. Press any key to stop the alarm.
3. Monitor the channel for the person calling the group for a message.
To ACCEPT the individual call, press the **[ENT]** key. The radio switches immediately to Channel 16.

Note: If a key is not pressed for 30 seconds (by default; refer to section “11.8 AUTO CHANNEL SWITCH TIME”) or longer the radio will automatically select Channel 16.

To SUSPEND the switching of the channel, press the **[002]** key.

To EXIT, press the **[CLR]** key. The radio reverts to the previous working channel.

4. Press the microphone's **PTT** switch and talk into the microphone to the other vessel.
5. Press the **[CLR]** key to return to radio operation.

NOTE

When there is an unread individual call, “” icon will appear on the display. You may review the unread individual call from the DSC log, refer to section “9.12.2 Reviewing Other Logged Calls.”

9.5.6 Setting up the Individual Call Ringer

When an individual call is received the radio will produce a ringing sound for 2 minutes. This selection allows the individual call ringer time to be changed.

1. Press and hold the **[CALL]** key until “Set up Menu” appears.
2. Rotate the **DIAL** knob to select “DSC Setup” menu.
3. Press the **[ENT]** key, then select “Individual Ring” with the **DIAL** knob.
4. Press the **[ENT]** key.
5. Rotate the **DIAL** knob to select ringing time of an individual call.
6. Press the **[ENT]** key to store the selected setting, then press the **[CLR]** key twice to return to radio operation.

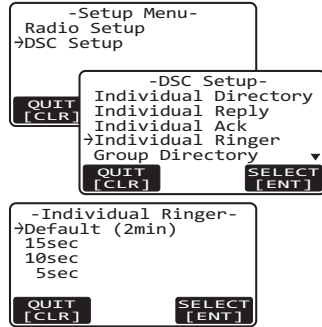

The **GX5500S** has the capability to turn off the individual ringer.

1. Press and hold the **[CALL]** key until “Set up Menu” appears.
2. Rotate the **DIAL** knob to select “DSC Setup” menu.
3. Press the **[ENT]** key, then select “DSC Beep” with the **DIAL** knob.
4. Press the **[ENT]** key.
5. Rotate the **DIAL** knob to select “Individual”, then press the **[ENT]** key.
6. Rotate the **DIAL** knob to select “Off”.
7. Press the **[ENT]** key to store the selected setting, then press the **[CLR]** key three times to return to radio operation.

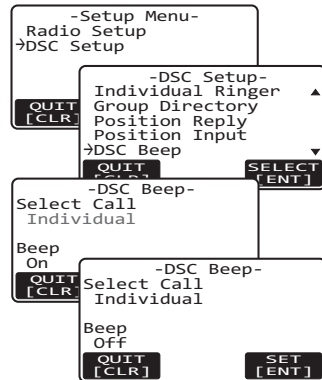

To re-enable the ringer, repeat the above procedure, rotating the **DIAL** knob to select “On” in step 6 above.

NOTE

The **GX5500S** may turn on and off the call ringer of the position request and position report calls as well as the individual and group calls.

9.6 GROUP CALL

This feature allows the user to contact a group of specific vessels (e.g. members of a yacht club) using DSC radios with group call function to automatically switch to a desired channel for voice communications. This function is very useful for yacht clubs and vessels traveling together that want to collectively make announcements on a predetermined channel. Up to 32 group MMSI (Maritime Mobile Service Identity Number) may be programmed.

9.6.1 Setting up the Group Call

For this function to operate, the same group MMSI must be programmed into all the DSC VHF radios within the group of vessels that will be using this feature. To understand group MMSI programming, first a ship MMSI has to be understood.

Ship MMSI: The first three digits called a MID (Mobile Identity Group) of a ship MMSI denote the country the ship registered for a MMSI. The last 6 digits are specific to the ships ID.

Ship MMSI Example: If your MMSI is “366123456”, “366” is MID which denote the country and “123456” is your ships MMSI.

Group MMSI:

- ❑ Group MMSI numbers are not assigned by the FCC or other organizations licensed to assign ship MMSI numbers.
- ❑ The first digit of a group MMSI is always set to “0” by the international rules. All Standard Horizon radios are preset so when programming a group MMSI the first digit is set to “0”.
- ❑ The USCG recommends programming the MID of a ships MMSI into the second, third and fourth digits of the group MMSI as it denotes the area the ship is located in.
- ❑ The last 5 digits are decided upon by persons in the group. This is an important step as all radios in the group must contain the same group MMSI so they can be contacted by each other. There is a chance that another group of vessels may program in the same group MMSI. If this happens, simply change one or more of the last 5 digits of the group MMSI.

1. Press and hold the **[CALL]** key until “Setup Menu” appears.
2. Rotate the **DIAL** knob to select “DSC Setup” menu.
3. Press the **[ENT]** key, then select “Group Directory” with the **DIAL** knob.

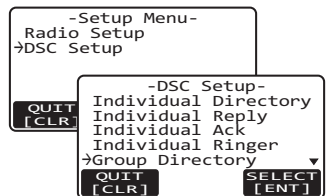

4. Press the **[ENT]** key, then select “Add” with the **DIAL** knob.
5. Press the **[ENT]** key.
6. Press an appropriate key on the keypad to enter the first letter of the name of the group you want to reference in the directory.
7. Press the **[ENT]** key to store the first letter in the name and step to the next letter to the right.
8. Repeat step 6 and 7 until the name is complete. The name can consist of up to eleven characters, if you do not use all eleven characters press the **[ENT]** key to move to the next space. This method can also be used to enter a blank space in the name.

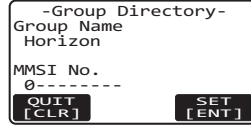
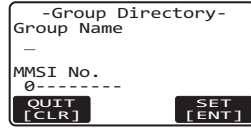
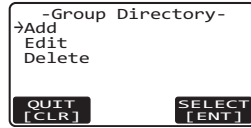

If a mistake was made entering in the name repeat pressing the **[HL]** key until the wrong character is selected, then press an appropriate key to correct the entry.

9. After the eleventh letter or a space has been entered, press and hold the **[ENT]** key to advance to the group MMSI number entry.
10. Press an appropriate number key on the keypad to select the second digit of the MMSI (nine digits: first digit permanently set to “0”) which you want to contact. Repeat this procedure until all eight digits of the MMSI number are entered.

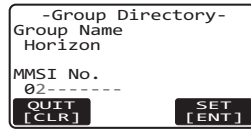

11. If a mistake was made entering in the MMSI number repeat pressing the **[HL]** key until the wrong digit is selected, then press an appropriate number key to correct the entry.
12. To store the data entered, press and hold the **[ENT]** key.
13. To enter another group address, repeat steps 5 through 12.
14. Press the **[CLR]** key three times to return to radio operation.

9.6.2 Transmitting a Group Call

9.6.2.1 Group Call using the Group Call Directory

1. Press the **[CALL]** key. The “DSC Menu” will appear.
2. Rotate the **DIAL** knob to select “Group”. (To cancel, press the **[CLR]** key.)
3. Press the **[ENT]** key. The group directory will appear.
4. Rotate the **DIAL** knob to select the group you want to contact.
5. Press the **[ENT]** key, rotate the **DIAL** knob to select the operating channel you want to communicate on, then press the **[ENT]** key.
6. Press the **[ENT]** key to transmit the group call signal.
7. When the group call signal is sent, the display will be as shown in the right.
8. After the group call is transmitted, all the radios in the group will switch to the designated channel.
9. Listen to the channel to make sure it is not busy, then press the microphone’s **PTT** switch and call the other vessel you desire to communicate with.

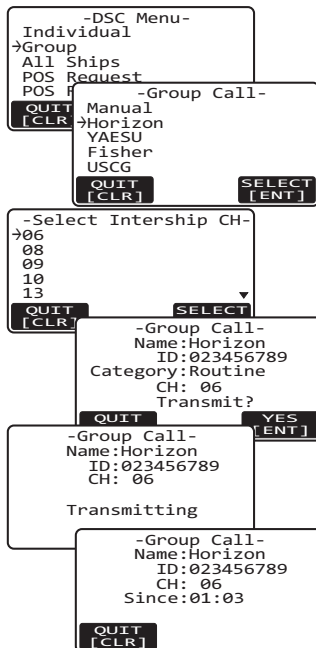

9.6.2.2 Group Call by Manually Entering a MMSI

You may enter an MMSI number manually to contact a group of vessels without storing the MMSI in the group call directory.

1. Press the **CALL** key. The “DSC Menu” will appear.
2. Rotate the **DIAL** knob to select “Group”. (To cancel, press the **CLR** key.)
3. Press the **ENT** key. The group directory will appear.
4. Rotate the **DIAL** knob to select “Manual” and press the **ENT** key.
5. Press an appropriate number key on the keypad to select the second number of the MMSI (nine digits: first digit permanently set to “0”) which you want to contact.
6. Repeat step 5 to set the MMSI number.
7. If a mistake was made entering in the MMSI number, repeat pressing the **HL** key until the wrong digit is selected, then press an appropriate number key to correct the entry.
8. When finished entering the MMSI number, press and hold the **ENT** key.
9. Rotate the **DIAL** knob to select the operating channel you want to communicate on, then press the **ENT** key.
10. Press the **ENT** key to transmit the group call signal.
11. After the group call is transmitted, all the radios in the group will switch to the designated channel.
12. Listen to the channel to make sure it is not busy, then press the microphone’s **PTT** switch and talk into the microphone to the group of vessels.

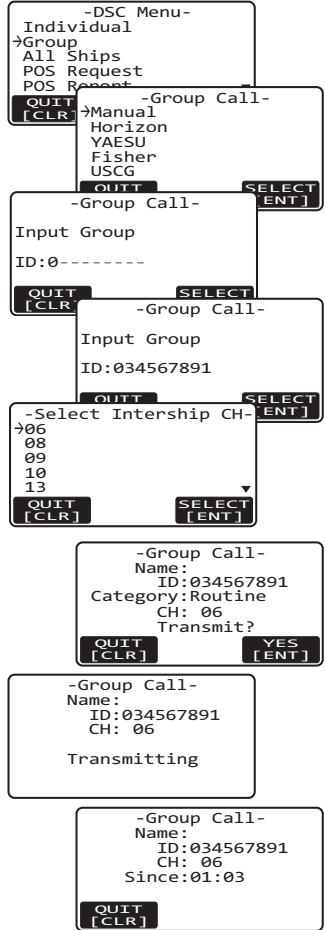

9.6.3 Receiving a Group Call

1. When a group call is received, the **GX5500S** will produce a ringing alarm sound. (DSC BEEP needs to be enabled to hear alarm.)
2. The display shows the group MMSI number.
3. Press any key to stop the alarm.
4. Monitor the channel for the person calling the group for a message.
To ACCEPT the group call, press the **[ENT]** key. The radio switches immediately to Channel 16.

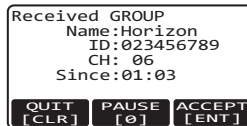

Note: If a key is not pressed for 30 seconds (by default; refer to section “11.8 AUTO CHANNEL SWITCH TIME”) or longer the radio will automatically select Channel 16.

To SUSPEND the switching of the channel, press the **[002]** key.

To EXIT, press the **[CLR]** key. The radio reverts to the previous working channel.

5. If you want to respond, monitor the channel to make sure it is clear, then press the microphone’s **PTT** switch and talk into the microphone to the group of vessels.
6. Press the **[CLR]** key to return to radio operation.

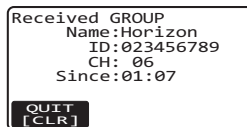

NOTE

When there is an unread group call, “” icon will appear on the display. You may review the unread group call from the DSC log, refer to section “9.12.2 Reviewing Other Logged Calls.”

9.6.4 Setting up the Group Call Ringer

The **GX5500S** has the capability to turn off the group call ringer.

1. Press and hold the **[CALL]** key until “Set up Menu” appears.
2. Rotate the **DIAL** knob to select “DSC Setup” menu.
3. Press the **[ENT]** key, then select “DSC Beep” with the **DIAL** knob.
4. Press the **[ENT]** key.
5. Rotate the **DIAL** knob to select “Group”, then press the **[ENT]** key.
6. Rotate the **DIAL** knob to select “Off”.
7. Press the **[ENT]** key to store the selected setting, then press the **[CLR]** key three times to return to radio operation.

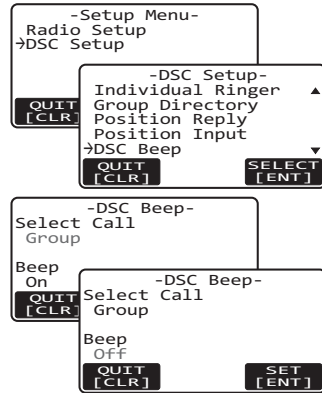

To re-enable the ringer, repeat the above procedure, rotating the **DIAL** knob to select “On” in step 6 above.

NOTE

The **GX5500S** is capable of turning on and off the call ringer of the position request and position report calls as well as the individual and group calls.

9.7 POSITION REQUEST

Advancements in DSC have made it possible to poll the location of another vessel and show the position of that vessel on the display of the **GX5500S**. Standard Horizon has taken this feature one step further, if any compatible GPS chart plotter is connected to the **GX5500S**, the polled position of the vessel is shown on the display of the GPS chart plotter making it easy to navigate to the location of the polled vessel. This is a great feature for anyone wanting to know the position of another vessel. For example your buddy that is catching fish, or finding the location of a person you are cruising with.

NOTE

The other vessel must have an operating GPS receiver connected to its DSC radio and must not have its radio set to deny position requests. (Refer to section “**9.5 INDIVIDUAL CALL**” to enter information into the individual directory.)

9.7.1 Setting up the Position Reply

The **GX5500S** can be setup to automatically (default setting) or manually send your position when requested by another vessel. This selection is important if you are concerned about someone polling the position of your vessel that you may not want to. In the manual mode you will see the MMSI or persons name shown on the display allowing you to choose to send your position to the requesting vessel.

1. Press and hold the **[CALL]** key until “Setup Menu” appears.
2. Rotate the **DIAL** knob to select “DSC Setup” menu.
3. Press the **[ENT]** key, then select “Position Reply” with the **DIAL** knob.
4. Press the **[ENT]** key, then select “Automatic” or “Manual”. In “Automatic” mode, after a DSC position request is received, the radio will automatically transmit your position. In “Manual” mode, the display of the **GX5500S** will show who is requesting the position and the **[ENT]** key on the radio has to be pressed to send your position to the requesting vessel.
5. Press the **[ENT]** key to store the selected setting.
6. Press the **[CLR]** key twice to return to radio operation.

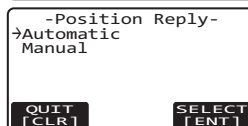
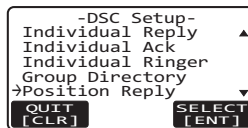
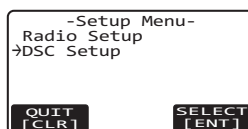

9.7.2 Transmitting a Position Request to Another Vessel

9.7.2.1 Position Request using the Individual/Position Call Directory

1. Press the **CALL** key. The “DSC Menu” will appear.
2. Rotate the **DIAL** knob to select “POS Request”, then press the **ENT** key. The individual/position call directory will appear.
3. Rotate the **DIAL** knob to select a name that you want to contact, then press the **ENT** key.
4. Press the **ENT** key to transmit the position request DSC call.
5. When the **GX5500S** receive the position from the polled vessel it is shown on the radio display and also transferred to a GPS chart plotter with NMEA DSC and DSE sentences.
6. Press the **CLR** key to return to radio operation.

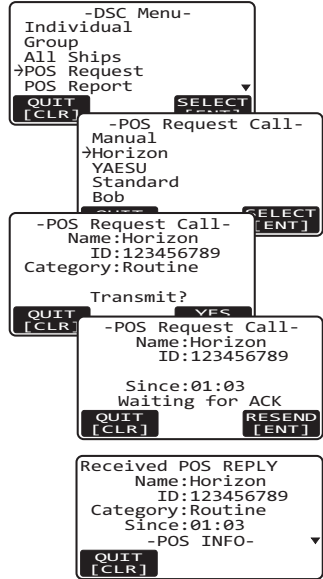

NOTE

If the **GX5500S** does not receive a position data from the polled vessel, the display will show “NO POSITION DATA.”

9.7.2.2 Position Request by Manually Entering a MMSI

You may enter an MMSI number manually to contact a vessel without storing the MMSI in the individual/position call directory.

1. Press the **[CALL]** key. The “DSC Menu” will appear.
2. Rotate the **DIAL** knob to select “POS Request”.
3. Press the **[ENT]** key. The individual/position call directory will appear.
4. Rotate the **DIAL** knob to select the “Manual,” then press the **[ENT]** key.
5. Press an appropriate number key on the keypad to select the first number of the MMSI (nine digits) which you want to contact.
6. Repeat step 5 to set the MMSI number.
7. If a mistake was made entering in the MMSI number, repeat pressing the **[H/L]** key until the wrong digit is selected.
8. When finished entering the MMSI number, press and hold the **[ENT]** key.
10. Press the **[ENT]** key to transmit the position request DSC call.
11. When the **GX5500S** receive the position from the polled vessel it is shown on the radio display and also transferred to the GPS chart plotter with NMEA DSC and DSE sentences.
12. Press the **[CLR]** key to return to radio operation.

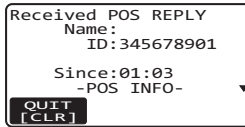
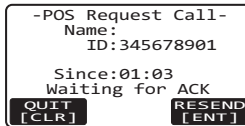
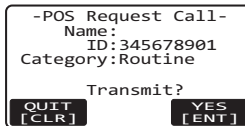
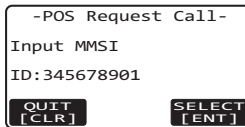
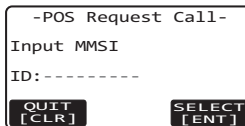
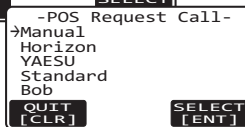
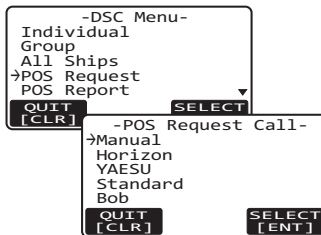

9.7.3 Receiving a Position Request

When a position request call is received from another vessel, a ringing alarm sounds and “POS REQUEST” will be shown in the display. Operation and transceiver function differs depending on the setting of the “Position Reply” in the “DSC Setup” menu.

Automatic reply:

1. When a position request call is received, a calling alarm sounds 4 times. Then requested position coordinates are transmitted automatically to the vessel requesting your vessels position. (DSC BEEP needs to be enabled to hear alarm.)
2. The display shows the MMSI number.

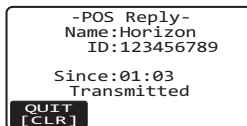

```
-POS Reply-  
Name:Horizon  
ID:123456789  
  
Since:01:03  
Transmitted  
  
QUIT  
[CLR]
```

Manual reply:

1. When a position request call is received from another vessel, the display will be as shown in the illustration at the right. (DSC BEEP needs to be enabled to hear alarm.)
2. A ringing alarm sounds 2 minutes. Press any key to stop the alarm.
3. To send your vessels position to the requesting vessel, press the **[ENT]** key. Or to exit from position request display, press the **[CLR]** key.

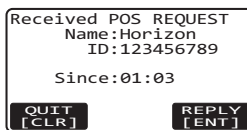

```
Received POS REQUEST  
Name:Horizon  
ID:123456789  
  
Since:01:03  
  
QUIT [CLR] REPLY [ENT]
```

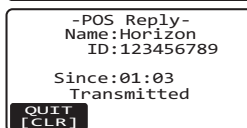

```
-POS Reply-  
Name:Horizon  
ID:123456789  
  
Since:01:03  
Transmitted  
  
QUIT  
[CLR]
```

9.7.4 Setting up the Position Request Ringer

The **GX5500S** has the capability to turn off the position request ringer.

1. Press and hold the **[CALL]** key until “Setup Menu” appears.
2. Rotate the **DIAL** knob to select “DSC Setup” menu.
3. Press the **[ENT]** key, then select “DSC Beep” with the **DIAL** knob.
4. Press the **[ENT]** key, then select “POS Request” with the **DIAL** knob.
5. Press the **[ENT]** key, then select “Off” with the **DIAL** knob.
6. Press the **[ENT]** key to store the selected setting.
7. Press the **[CLR]** key three times to return to radio operation.

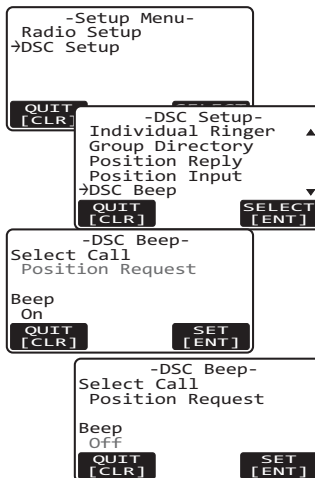

To re-enable the ringer tone, repeat the above procedure, rotating the **DIAL** knob to select “On” in the step 5 above.

9.8 POSITION REPORT

The feature is similar to the position request, however instead of requesting a position of another vessel this function allows you to send your position to another vessel. Your vessel must mark the connected GPS receiver for the **GX5500S** to send the position.

NOTE

To transmit a position report call, a GPS must be connected to the radio. (Refer to section “9.5 INDIVIDUAL CALL” to enter information into the individual directory.)

9.8.1 Transmitting a DSC Position Report Call

9.8.1.1 DSC Position Report Call using the Individual/Position Call Directory

1. Press the **[CALL]** key. The “DSC Menu” will appear.
2. Rotate the **DIAL** knob to select “POS Report”. (To cancel, press the **[CLR]** key.)
3. Press the **[ENT]** key. The transceiver will beep, and the individual/position call directory will appear.
4. Rotate the **DIAL** knob to select the name in the directory, then press the **[ENT]** key.
6. Press the **[ENT]** key to send your position to the selected vessel.
7. Press the **[CLR]** key to return to radio operation.

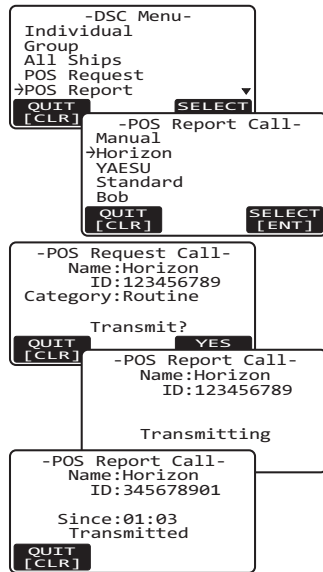

9.8.1.2 DSC Position Report Call by Manually Entering a MMSI

You may enter an MMSI number manually to contact a vessel without storing the MMSI in the individual/position call directory.

1. Press the **CALL** key. The “DSC Menu” will appear.
2. Rotate the **DIAL** knob to select “POS REPORT”. (To cancel, press the **CLR** key.)
3. Press the **ENT** key. The transceiver will beep, and the “POS Report Call” menu will appear.
4. Rotate the **DIAL** knob to select “MANUAL”, then press the **ENT** key.
5. Press an appropriate number key on the keypad to select the first number of the MMSI which you want to contact.
6. Repeat step 5 to set the MMSI number.
7. If a mistake was made entering in the MMSI number, repeat pressing the **H/L** key until the wrong digit is selected, then press an appropriate number key to correct the entry.
8. When finished entering the MMSI number, press and hold the **ENT** key.
9. Press the **ENT** key to send your position to the selected vessel.
10. Press the **CLR** key to return to radio operation.

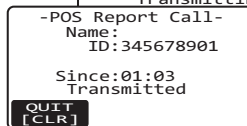
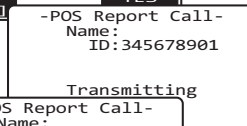
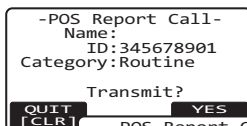
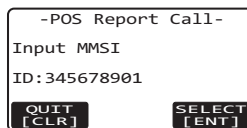
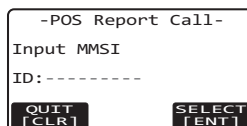
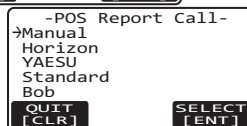
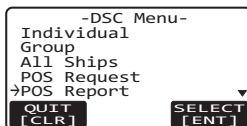

9.8.2 Receiving a DSC Position Report Call

When another vessel transmits their vessels location to the **GX5500S** the following will happen:

1. A ringing sound will be produced when the call is received and NMEA sentences DSC, DSE are outputted so the position can be shown on a connected chart plotter or a computer. (DSC BEEP needs to be enabled to hear the alarm.)
2. Press any key to stop the ringing.
3. Rotate the **DIAL** knob to see position information of the station.
4. To exit to radio mode, press the **[CLR]** key.

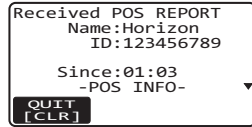

Received POS REPORT
Name:Horizon
ID:123456789

Since:01:03
-POS INFO-
QUIT [CLR]

9.8.3 Setting up the Position Report Ringer

The **GX5500S** has the capability to turn off the position report ringer.

1. Press and hold the **[CALL]** key until “Set up Menu” appears.
2. Rotate the **DIAL** knob to select “DSC Setup” menu.
3. Press the **[ENT]** key, then select “DSC Beep” with the **DIAL** knob.
4. Press the **[ENT]** key, then select “POS Report” with the **DIAL** knob.
5. Press the **[ENT]** key, then select “Off” with the **DIAL** knob.
6. Press the **[ENT]** key to store the selected setting.
7. Press the **[CLR]** key three times to return to radio operation.

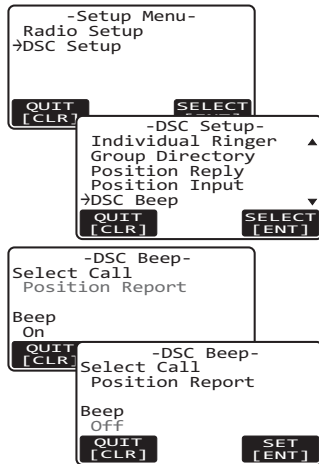

-Setup Menu-
Radio Setup
→DSC Setup
QUIT [CLR] SELECT

-DSC Setup-
Individual Ringer
Group Directory
Position Reply
Position Input
→DSC Beep
QUIT [CLR] SELECT [ENT]

-DSC Beep-
Select Call
Position Report
Beep
On
QUIT [CLR]

-DSC Beep-
Select Call
Position Report
Beep
Off
QUIT [CLR] SET [ENT]

To re-enable the ringer tone, repeat the above procedure, rotating the **DIAL** knob to select “On” in the step 5 above.

9.9 MANUAL INPUTTING A GPS POSITION (LAT/LON)

This selection allows the latitude and longitude of your vessel to be manually entered so a DSC distress or a position report call will contain position information. This feature may be useful when a GPS connected to the **GX5500S** fails to supply position to the radio.

1. Press and hold the **[CALL]** key until "Setup Menu" appears, then select "DSC Setup" with the **DIAL** knob.
2. Press the **[ENT]** key, then select "Position Input" with the **DIAL** knob.
3. Press the **[ENT]** key. The display will be as shown in the illustration on the right.
4. Enter UTC time in the 24-hour format and the latitude and longitude of your vessel. Press an appropriate number key on the keypad to select the number. If you make a mistake, you may backspace the cursor by pressing the **[HL]** key.
5. To store the data entered, press and hold the **[ENT]** key.
6. Press the **[CLR]** key twice to return to radio operation.

The "M" icon will appear on the display instead of the satellite icon (📶).

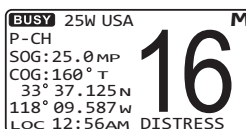
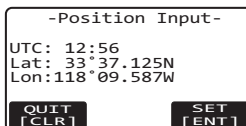
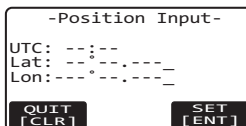
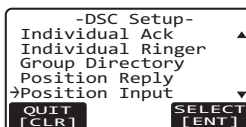

9.10 DSC TEST CALL

This function is used to contact another DSC equipped vessel or USCG station to ensure the DSC functions of the radio are operating.

NOTE

To use this feature, the radio you will be transmitting the test call to needs to have the DSC test feature.

9.10.1 DSC Test Call by using Individual/Position Call Directory

1. Press the **CALL** key. The “DSC Menu” will appear.
2. Rotate the **DIAL** knob to select “DSC Test”, then press the **ENT** key.
3. Rotate the **DIAL** knob to select the ship’s name and press the **ENT** key.
4. Press the **ENT** key to transmit the DSC test call to the other vessel.

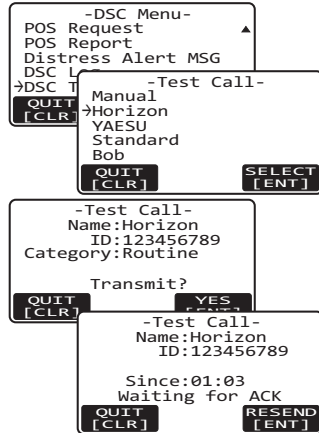

NOTE

After the radio receives a test call reply from the vessel that was called, the radio will ring and show the image as in the right, which confirms the radio you called received the test call.

The screenshot shows the received test call acknowledgment:

Received TEST ACK
Name:Horizon
ID:123456789
Since:01:03
QUIT [CLR]

9.10.2 DSC Test Call by Manually Entering a MMSI

1. Press the **[CALL]** key. The “DSC Menu” will appear.
2. Rotate the **DIAL** knob to select “DSC Test”, then press the **[ENT]** key.
3. Rotate the **DIAL** knob to select “Manual” and press the **[ENT]** key.
4. Press an appropriate number key on the keypad to select the first number in the MMSI and press the **[ENT]** key.
5. Repeat step 4 until all the digits of the MMSI are shown on the display.
6. Press and hold the **[ENT]** key to show the test call page.
7. Press the **[ENT]** key to transmit the DSC test call to the other vessel.

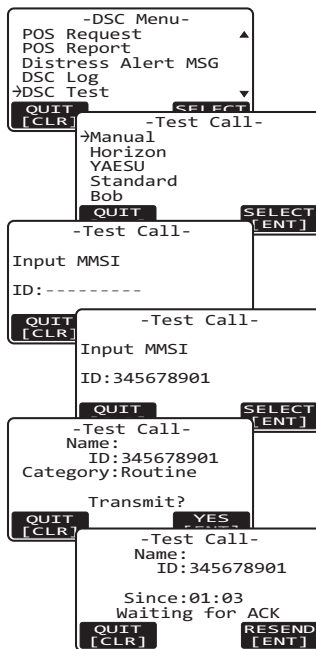

NOTE

After the radio receives a test call reply from the vessel that was called, the radio will ring and show the image as in the right, which confirms the radio you called received the test call.

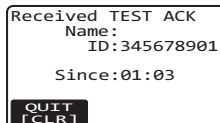

9.10.3 Receiving a DSC Test Call

When another vessel transmits a test call to the **GX5500S** the following will happen:

1. The radio will automatically respond to the calling vessel and displays the information as in the right.
2. To exit to radio mode, press the **CLR** key.

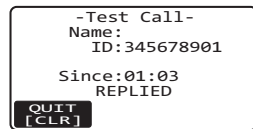

9.11 POLLING CALL

The **GX5500S** has the capability to track another vessel.

9.11.1 Transmitting a Polling Call to Another Vessel

9.11.1.1 Polling Call using the Individual/Position Call Directory

1. Press the **[CALL]** key. The “DSC Menu” will appear.
2. Rotate the **DIAL** knob to select “Polling”, then press the **[ENT]** key.
3. Rotate the **DIAL** knob to select a name that was stored in the individual/position call directory, then press the **[ENT]** key.
4. Press the **[ENT]** key to transmit the polling call.
5. After a polling call is transmitted, if the reply signal is not received, “Waiting for ACK” is shown on the display which means the **GX5500S** is waiting for the vessel you called to send an acknowledgement.
6. To transmit the call again, press the **[ENT]** key.
7. When an acknowledgement is received from the polled vessel, the **GX5500S** will show the display as in the right.
8. Press the **[CLR]** key to return to radio operation.

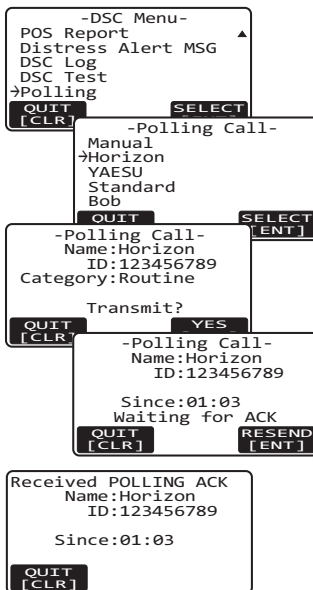

9.11.1.2 Polling Call by Manually Entering a MMSI

This feature allows you to contact a vessel by manually entering the MMSI of the ship you want to track.

1. Press the **CALL** key. The “DSC Menu” will appear.
2. Rotate the **DIAL** knob to select “Polling”, then press the **ENT** key.
3. Rotate the **DIAL** knob to select “Manual” and press the **ENT** key.
4. Press an appropriate number key on the keypad to select the first number in the MMSI.
5. Repeat step 4 until all the digits of the MMSI are shown on the display.
6. If a mistake was made entering in the MMSI number, repeatedly press the **H/L** key until the wrong digit is selected, then press an appropriate number key to correct the entry.
7. When finished entering the MMSI number, press and hold the **ENT** key.
8. Press the **ENT** key to transmit the polling call.
9. When an acknowledgement is received from the polled vessel, the **GX5500S** will show the display as in the right.
10. Press the **CLR** key to return to radio operation.

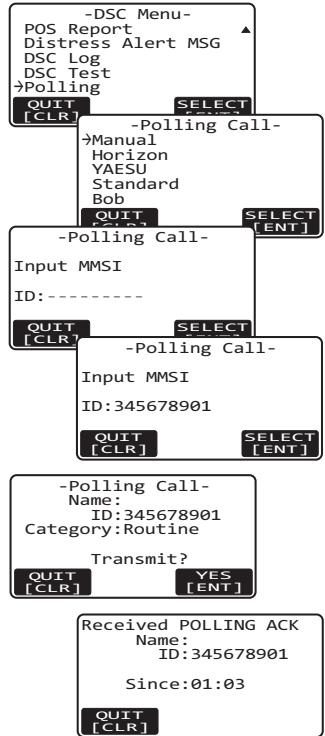

9.11.2 Receiving a Polling Call

When another vessel transmits a polling call to the **GX5500S** the following will happen:

1. The radio will automatically respond to the calling vessel and displays the information as in the right.
2. To exit to radio mode, press the **CLR** key.

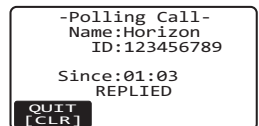

9.12 DSC LOG OPERATION

The **GX5500S** logs transmitted calls, received DSC distress calls, and other calls (individual, group, all ships, etc.). The DSC log feature is similar to an answer machine where calls are recorded for review and a “☑” icon will appear on the radios display. The **GX5500S** can store up to 30 distress calls, and up to 80 other calls (all ships calls, individual calls, group calls, position report, position request ack, test call ack, and polling calls).

NOTE

When the “DSC Log” menu is selected, the **GX5500S** may display high-priority logged call automatically.

9.12.1 Reviewing Logged DSC Distress Calls

The **GX5500S** allows logged DSC distress calls to be reviewed.

1. Press the **[CALL]** key. The “DSC Menu” will appear.
2. Rotate the **DIAL** knob to select “DSC Log” menu.
3. Press the **[ENT]** key, then rotate the **DIAL** knob to select “Distress Log”.
4. Press the **[ENT]** key, then rotate the **DIAL** knob to select the station (name or MMSI number) you want to review.
5. Press the **[ENT]** key to review details for the selected station.
6. Press the **[CLR]** key to go back to the DSC distress call list.

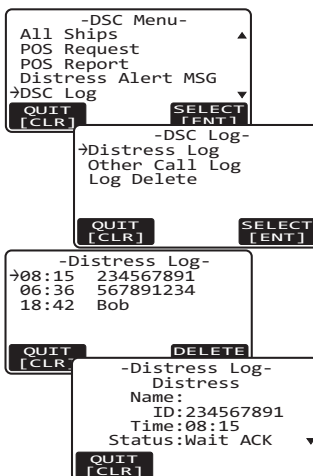

9.12.2 Reviewing Other Logged Calls

Reviewing other logged calls (all ships calls, individual calls, group calls, position report, position request ack, test call ack, and polling calls).

1. Press the **[CALL]** key. The “DSC Menu” will appear.
2. Rotate the **DIAL** knob to select “DSC Log” menu.
3. Press the **[ENT]** key, then rotate the **DIAL** knob to select “Other Call Log”.
4. Press the **[ENT]** key, then rotate the **DIAL** knob to select the station (name or MMSI number) you want to review.
5. Press the **[ENT]** key to review details for the selected station.
6. Press the **[CLR]** key to go back to the DSC other call list.

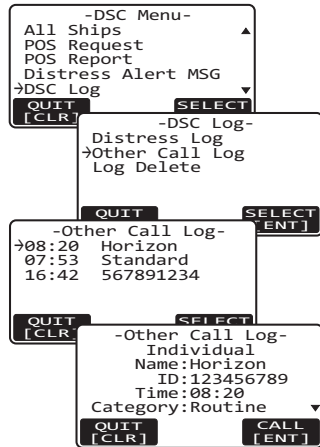

9.12.3 Deleting a Call from the “DSC LOG” Directory

1. Press the **[CALL]** key. The “DSC Menu” will appear.
2. Rotate the **DIAL** knob to select “DSC Log” menu.
3. Press the **[ENT]** key, then rotate the **DIAL** knob to select “Log Delete” menu.
4. Press the **[ENT]** key, then rotate the **DIAL** knob to select the category (“Distress Log” or “Other Call Log”) to be deleted.
5. Press the **[ENT]** key.

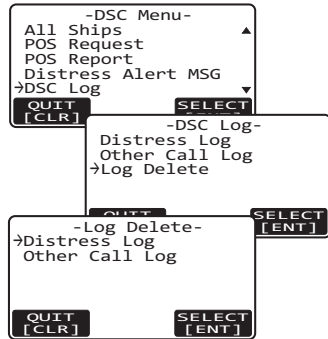

6.

1) If you want to delete all logged calls at one time, select "All Log Delete" with the **DIAL** knob, then press the **[ENT]** key.

2) If you want to delete one of the logged stations, select "View Log List" with the **DIAL** knob, then press the **[ENT]** key. Rotate the **DIAL** knob to select the station (name or MMSI number) to be deleted, then press the **[ENT]** key.

7. The display will show "Are you sure?". Press the **[ENT]** key.

8. Press the **[CLR]** key several times to return to radio operation.

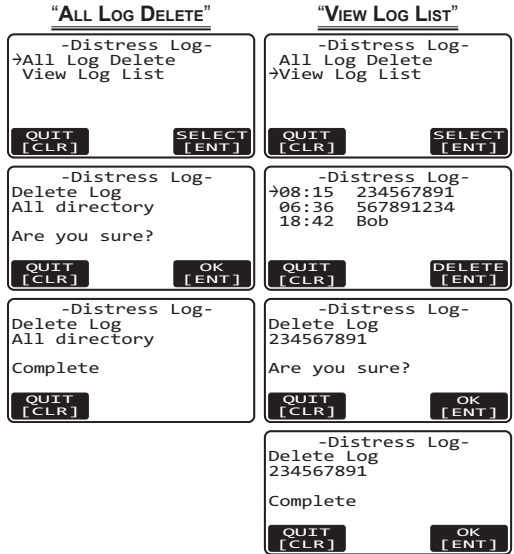

10 RADIO SETUP

The optional **RAM3 (CMP30)** Remote Access Microphone can also adjust items in the setup menu using the following procedures.

10.1 CONTRAST

This selection sets up the display contrast for overhead or dash installations.

1. Press and hold the **[CALL]** key until “Setup Menu” appears, then select “Radio Setup” with the **DIAL** knob.
2. Press the **[ENT]** key, then rotate the **DIAL** knob to select “Contrast”.
3. Press the **[ENT]** key.
4. Rotate the **DIAL** knob to select the desired level. The contrast level can be set from “0” to “31”.
5. Press the **[ENT]** key to store the selected level.
6. Press the **[CLR]** key twice to return to radio operation.

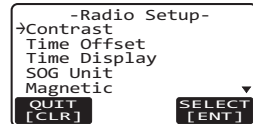

10.2 TIME OFFSET

From the factory the **GX5500S** shows GPS satellite time or UTC time. A time offset is needed to show the local time in your area. The time offset must be changed in order for the radio to display the current time in your area. Refer to section “**6.7 CHANGING THE GPS TIME**” for setting.

10.3 TIME DISPLAY

This selection allows the radio to show UTC time or local time with the offset. Refer to section “**6.8 CHANGING THE TIME DISPLAY**” for setting.

10.4 SOG UNIT

Allows navigation displays to be shown in “Knots”, “Miles/Hour” or “Kilometers/Hour” (for speed).

NOTE

The NMEA signal from an external GPS or chart plotter must be received.

1. Press and hold the **[CALL]** key until “Setup Menu” appears, then select “Radio Setup” with the **DIAL** knob.
2. Press the **[ENT]** key, then rotate the **DIAL** knob to select “SOG Unit”.
3. Press the **[ENT]** key, then rotate the **DIAL** knob to select desired unit. Available selections are KTS (Knots), MPH (Miles/Hour), or KMH (Kilometers/Hour) for speed
4. Press the **[ENT]** key to store the selected setting.
5. Press the **[CLR]** key twice to return to radio operation.

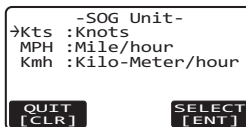
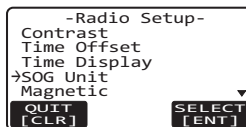

10.5 MAGNETIC

Refer to section “6.9 CHANGING COG TO TRUE OR MAGNETIC”.

10.6 PRIORITY CHANNEL

By default the radio priority channel is set to Channel 16. This procedure allows the radio to use a different priority channel when priority scanning.

1. Press and hold the **[CALL]** key until “Setup Menu” appears, then select “Radio Setup” with the **DIAL** knob.
2. Press the **[ENT]** key, then select “Priority CH” with the **DIAL** knob.
3. Press the **[ENT]** key.
4. Rotate the **DIAL** knob to select the desired channel to be the priority channel.
5. Press the **[ENT]** key to store the selected setting.
6. Press the **[CLR]** key twice to return to radio operation.

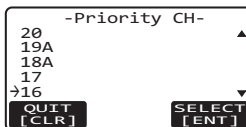
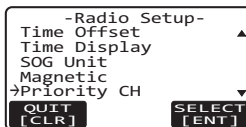
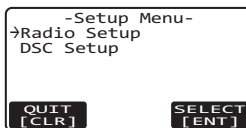

10.7 SCAN TYPE

Refer to section “8.10.1 Scan Type Selection”.

10.8 SCAN RESUME TIME

This selection is used to select the time the **GX5500S** waits after a transmission ends before the radio starts to scan channels again. The default setting is 2 seconds.

1. Press and hold the **[CALL]** key until “Setup Menu” appears, then select “Radio Setup” with the **DIAL** knob.
2. Press the **[ENT]** key, then select “Scan Resume” with the **DIAL** knob.
3. Press the **[ENT]** key.
4. Rotate the **DIAL** knob to select the desired resume time, default is 2 seconds. The resume time can be set to “1SEC” through “5SEC”, or “OFF”. In the “OFF” selection, the scanner will resume after the other station stops transmitting (carrier drops).
5. Press the **[ENT]** key to store the selected setting.
6. Press the **[CLR]** key twice to return to radio operation.

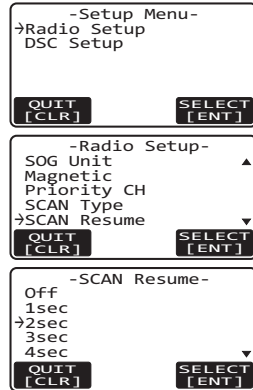

10.9 KEY BEEP

This selection is used to select the beep tone volume level when a key is pressed.

1. Press and hold the **[CALL]** key until “Setup Menu” appears, then select “Radio Setup” with the **DIAL** knob.
2. Press the **[ENT]** key, then rotate the **DIAL** knob to select “Key Beep”.
3. Press the **[ENT]** key.
4. Rotate the **DIAL** knob to select the desired level. The beep level can be set from “Level 1” to “Level 6”, “High”, or “Off”.
5. Press the **[ENT]** key to store the selected level.
6. Press the **[CLR]** key twice to return to radio operation.

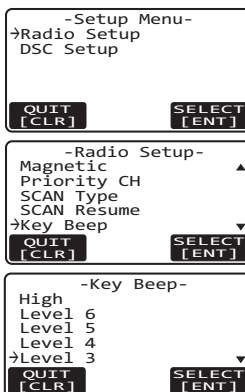

10.10 WEATHER ALERT

This menu selection allows you to toggle the WX alert on or off. The default setting is “ON SCAN and WX CH”.

1. Press and hold the **[CALL]** key until “Setup Menu” appears, then select “Radio Setup” with the **DIAL** knob.
2. Press the **[ENT]** key, then select “Weather Alert” with the **DIAL** knob.
3. Press the **[ENT]** key.
4. Rotate the **DIAL** knob to select the desired WX alert mode. The WX alert mode can be set to “On WX CH”, “On SCAN”, “On SCAN and WX CH”, or “Off”.
5. Press the **[ENT]** key to store the selected setting.
6. Press the **[CLR]** key twice to return to radio operation.

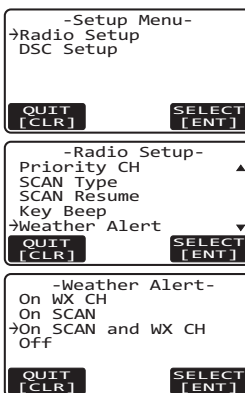

10.11 CHANNEL NAME

When in the radio mode, the display will show a name under the channel number. This name describes the use of the channel. The radio has the capability to customize the name by the procedure below.

Example: CH69 PLEASURE to HOOKUP

1. Press and hold the **[CALL]** key until "Setup Menu" appears, then select "Radio Setup" with the **DIAL** knob.
2. Press the **[ENT]** key, then select "CH Name" with the **DIAL** knob.
3. Press the **[ENT]** key.
4. Rotate the **DIAL** knob to select the channel to be named, then press the **[ENT]** key.
5. Press an appropriate key on the keypad to enter the first letter of the new channel name.
6. Press the **[ENT]** key to store the first letter in the name and step to the next letter to the right.
7. Repeat step 5 and 6 until the name is completed. The name can consist of up to 16 characters, if you do not use all 16 characters press the **[ENT]** key to move to the next space. This method can also be used to enter a blank space in the name. If a mistake was made entering in the name repeatedly press the **[H/L]** key until the wrong character is selected, then press an appropriate key to correct the entry.
8. Press and hold the **[ENT]** key to save the name.
9. If you want to enter the name of another channel, repeat steps 4 through 8.
10. Press the **[CLR]** key three times to return to radio operation.

```
-Setup Menu-
→Radio Setup
DSC Setup

[QUIT [CLR]] [SELECT [ENT]]
```

```
-Radio Setup-
SCAN Type ▲
SCAN Resume
Key Beep
Weather Alert
→CH Name ▼

[QUIT [CLR]] [SELECT [ENT]]
```

```
-CH Name-
Select CH
16
CH Name
DISTRSS

[QUIT [CLR]] [SET [ENT]]
```

```
-CH Name-
Select CH
69
CH Name
PLEASURE

[QUIT [CLR]] [SET [ENT]]
```

```
-CH Name-
Select CH
69
CH Name
HLEASURE

[QUIT [CLR]] [SET [ENT]]
```

```
-CH Name-
Select CH
69
CH Name
HOOKUP

[QUIT [CLR]] [SET [ENT]]
```

10.12 UNIT NAME

This function allows you to change the name of the radio or **RAM3** second station microphone.

Example: “Radio - Cabin”, “RAM1 - Flybridge”.

1. Connect the **RAM3** second station microphone to the **GX5500S**.
2. Press and hold the **[CALL]** key until “Setup Menu” appears, then select “Radio Setup” with the **DIAL** knob.
3. Press the **[ENT]** key, then rotate the **DIAL** knob to select “Unit Name”.
4. Press the **[ENT]** key.
5. Rotate the **DIAL** knob to select the unit (“Radio” or “RAM1”) to be named, then press the **[ENT]** key.
6. Press an appropriate key on the keypad to enter the first letter of the new channel name.
7. Press the **[ENT]** key to store the first letter in the name and step to the next letter to the right.
8. Repeat step 6 and 7 until the name is completed. The name can consist of up to 8 characters, if you do not use all 8 characters press the **[ENT]** key to move to the next space. This method can also be used to enter a blank space in the name. If a mistake was made entering in the name repeatedly press the **[H/L]** key until the wrong character is selected, then press an appropriate key to correct the entry.
9. Press and hold the **[ENT]** key to enter the name.
10. If you want to enter the name of the connected **RAM3** or radio, repeat steps 5 through 9.
11. Press the **[CLR]** key three times to return to radio operation.

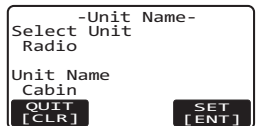
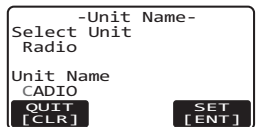
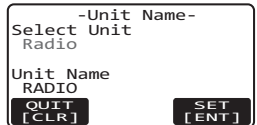
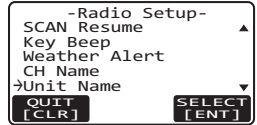

10.13 TREBLE AND BASS AUDIO TONE CONTROL

Refer to section “6.10 TREBLE AND BASS AUDIO TONE CONTROL”.

10.14 FOG ALERT TONE FREQUENCY

The function allows the radio to be setup to send the proper fog frequency which is dependant on vessel size, shown below:

- 70 - 200Hz: Vessel that are 660 feet (200 meters) or more in length
- 130 - 350Hz: Vessel that are 247.5 feet (75 meters) or more but less than 660 feet (200 meters) in length
- 250 - 525Hz: Vessel that are 66 feet (20 meters) or more but less than 247.5 feet (75 meters) in length
- 250 - 525Hz: Vessel that are 39.6 feet (12 meters) or more but less than 66 feet (20 meters) in length

1. Press and hold the **[CALL]** key until “Setup Menu” appears.
2. Rotate the **DIAL** knob to select “Radio Setup” menu.
3. Press the **[ENT]** key, then rotate the **DIAL** knob to select “FOG Frequency”.
4. Press the **[ENT]** key.
5. Rotate the **DIAL** knob to select the desired tone frequency.
6. Press the **[ENT]** key to store the selected level.
7. Press the **[CLR]** key two times to return to radio operation.

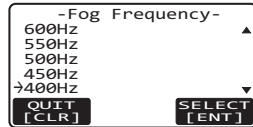
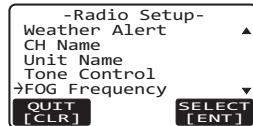

NOTE

By default the radio Fog frequency is set to 400Hz. In most cases this frequency should not be changed unless the vessel is very large.

10.15 CALENDAR SETUP

The **GX5500S** has a built in clock to remember date, time, latitude and longitude. Connecting a GPS to the **GX5500S** is very important as it not only will be used to update the calendar automatically but also when a DSC distress call is transmitted will send your vessel's location to other vessels to aid in the rescue. Refer to section "6.5 ACCESSORY CABLES."

With GPS Connected

When a GPS is connected, the **GX5500S** will automatically store the calendar date and time information within one hour after being connected.

With GPS Unconnected

If a GPS is not connected to the **GX5500S**, the date and time has to be manually entered into the Calendar Menu in order for the clock to operate. The time you will enter will be your local time in UTC format. Enter the date and time with the procedure below.

- 1) Find your location on the Standard Time chart below.

NOTE

The chart below shows the Standard Time. For Daylight Savings subtract one hour from your offset.

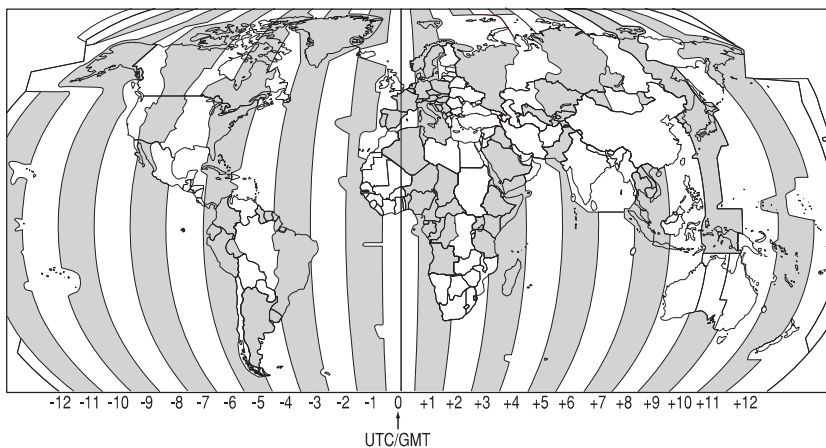

2) Calculate your local UTC time.

NOTE

If you are west of UTC time you will add the offset to your time.
If you are east of UTC time you will subtract the offset from your time.

Examples:

Los Angeles

Offset	-8
Time (convert local time to 24 hour)	4:00PM (local) or 16:00 (24h)
Calculate 24 hour local + Offset (East of UTC)	16:00 + 08:00 = 22:00

New York

Offset	-5
Time (convert local time to 24 hour)	4:00PM (local) or 16:00 (24h)
Calculate 24 hour local + Offset (East of UTC)	16:00 + 05:00 = 21:00

Rome

Offset	+1
Time (convert local time to 24 hour)	4:00PM (local) or 16:00 (24h)
Calculate 24 hour local + Offset (East of UTC)	16:00 - 01:00 = 15:00

3) Input your local UTC time through the setup menu.

1. Press and hold the **[CALL]** key until “Setup Menu” appears, then select “Radio Setup” with the **DIAL** knob.
2. Press the **[ENT]** key, and then select “Calendar” with the **DIAL** knob.
3. Press the **[ENT]** key, and then select “Calendar” with the **DIAL** knob.
4. Press the **[ENT]** key.
5. Select “Date (20YY/MM/DD)” with the **DIAL** knob.
6. Press the **[ENT]** key.
7. Enter the current date (yr/mo/day) from the keypad.
8. If a mistake was made entering repeat pressing the **[HL]** key until the wrong number is selected, then enter the correct number.
9. Using the Standard time table above, calculate the UTC time of your position.
Note: For daylight savings time subtract one hour to the offset in your time zone.
10. To enter the time, press the **[ENT]** key until the first digit in the “Time (hh/mm [UTC])” is selected on the display, then enter the time from the keypad.
11. Press and hold down the **[ENT]** key to store the selected setting.
12. Select “Update” with the **DIAL** knob, then press the **[ENT]** key.
13. Turn the **DIAL** knob to select the method of the time adjustment between “Automatic” and “Manual.”
14. Press the **[ENT]** key to store the selected setting.
15. To exit this menu and return to radio operation mode press the **[16/9]** key.

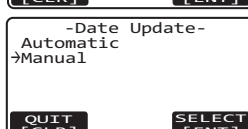
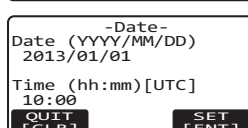
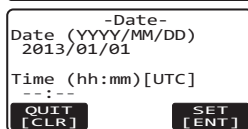
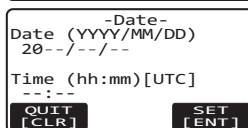
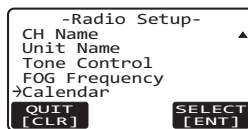
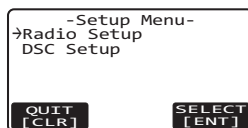

11 DSC SETUP

11.1 INDIVIDUAL DIRECTORY

The **GX5500S** has a DSC directory that allows you to store a vessel's or person's name and the MMSI number associated with vessels you wish to transmit individual calls, position requests and position reports.

To transmit an individual call you must program this directory with information of the persons you wish to call, similar to a cellular phones telephone directory.

Refer to section “**9.5.1 Setting up the Individual / Position Call Directory**” for programming.

11.2 INDIVIDUAL REPLY

This menu item sets up the radio to automatically (default setting) or manually respond to a DSC individual call requesting you to switch to a working channel for voice communications. When “Manual” is selected the MMSI of the calling vessel is shown allowing you to see who is calling. This function is similar to caller ID on a cellular phone.

Refer to section “**9.5.2 Setting up the Individual Call Reply**” for setting.

11.3 INDIVIDUAL ACKNOWLEDGMENT

The radio can be setup to transmit a reply automatically (default) or set so the radio will not reply to an individual call.

Refer to section “**9.5.3 Setting up the Individual Call Acknowledgment**” for setting.

11.4 INDIVIDUAL RINGER

The radio can be setup to ring like a telephone to alert you the radio received a DSC individual call. The default setting is 2 minutes, however this can be changed to 15, 10 or 5 seconds.

Refer to section “**9.5.6 Setting up the Individual Call Ringer**” for setting.

11.5 GROUP DIRECTORY

For this function to operate, the same group MMSI must be programmed into all the DSC VHF radios within the group of vessels that will be using this feature.

Refer to section “**9.6.1 Setting up the Group Call**” for programming.

11.6 POSITION REPLY

The **GX5500S** can be set up to automatically (default setting) or manually send your position when requested by another vessel. This selection is important if you are concerned about someone polling the position of your vessel that you may not want to. In the manual mode you will see the MMSI or person's name shown on the display allowing you to choose to send your position to the requesting vessel.

Refer to section “9.7.1 Setting up the Position Reply” for setting.

11.7 DSC BEEP

This feature allows the alarm beeps to be turned on (default setting) or off when a DSC call is received. The DSC calls that can be customized are: Individual, Group, All Ships, Position Request, Position Report, Geographical Call using the procedure below:

1. Press and hold the **[CALL]** key until “Setup Menu” appears.
2. Rotate the **DIAL** knob to select “DSC Setup”.
3. Press the **[ENT]** key, then select “DSC Beep” with the **DIAL** knob.
4. Press the **[ENT]** key, then rotate the **DIAL** knob to select the desired DSC call type and press the **[ENT]** key.
5. Rotate the **DIAL** knob to turn “On” or “Off” the DSC beep and press the **[ENT]** key.
6. Press the **[CLR]** key three times to return to radio operation.

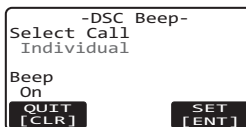
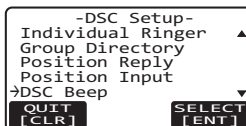

11.8 AUTO CHANNEL SWITCH TIME

When a DSC distress or an all ships (urgency or safety) call is received, the **GX5500S** will automatically switch to Channel 16.

This menu selection allows the automatic switch time to be changed. The default selection is 30 seconds.

1. Press and hold the **[CALL]** key until “Setup Menu” appears.
2. Rotate the **DIAL** knob to select “DSC Setup”.
3. Press the **[ENT]** key, then select “Auto CH Switch Time” with the **DIAL** knob.
4. Press the **[ENT]** key, then rotate the **DIAL** knob to select the desired time and press the **[ENT]** key.
5. Press the **[CLR]** key twice to return to radio operation.

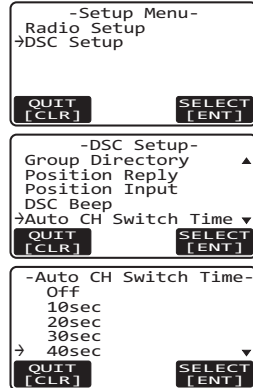

11.9 NO ACTION TIMER ON MENU OPERATION

If a key is not pressed during the setup menu or the DSC menu mode, the **GX5500S** will automatically return to radio operation.

This menu selection allows the automatic switch time to be changed. The default selection is 10 minutes.

1. Press and hold the **[CALL]** key until “Setup Menu” appears.
2. Rotate the **DIAL** knob to select “DSC Setup”.
3. Press the **[ENT]** key, then select “No Act Timer on Menu” with the **DIAL** knob.
4. Press the **[ENT]** key, then rotate the **DIAL** knob to select the desired time and press the **[ENT]** key.
5. Press the **[CLR]** key twice to return to radio operation.

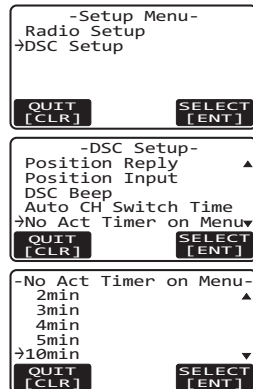

11.10 NO ACTION TIMER ON DSC OPERATION

If a key is not pressed during the DSC operation, the **GX5500S** will automatically return to radio operation.

This menu selection allows the automatic switch time to be changed. The default selection is 15 minutes.

1. Press and hold the **[CALL]** key until “Setup Menu” appears.
2. Rotate the **DIAL** knob to select “DSC Setup”.
3. Press the **[ENT]** key, then select “No Act Timer on DSC” with the **DIAL** knob.
4. Press the **[ENT]** key, then rotate the **DIAL** knob to select the desired time and press the **[ENT]** key.
5. Press the **[CLR]** key twice to return to radio operation.

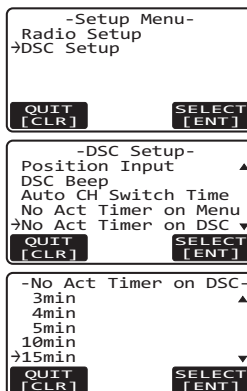

11.11 NO ACTION TIMER ON DISTRESS OPERATION

If a key is not pressed during the distress operation, the **GX5500S** will automatically return to radio operation.

This menu selection allows the automatic switch time to be changed. The default selection is “OFF”.

1. Press and hold the **[CALL]** key until “Setup Menu” appears.
2. Rotate the **DIAL** knob to select “DSC Setup”.
3. Press the **[ENT]** key, then select “No Act Timer on DIST” with the **DIAL** knob.
4. Press the **[ENT]** key, then rotate the **DIAL** knob to select the desired time and press the **[ENT]** key.
5. Press the **[CLR]** key twice to return to radio operation.

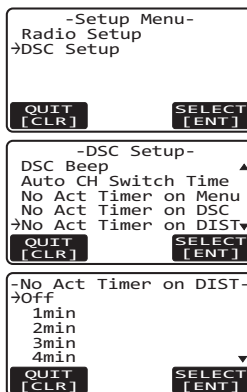

12 BLUETOOTH SETUP

When the optional **BU-1** Bluetooth adapter unit is installed to the **GX5500S**, the item “Bluetooth” appears on the setup menu.

12.1 VOX FUNCTION

This selection sets up the automatic activation of the talking mode of the connected Bluetooth devices.

1. Press and hold the **[CALL]** key until “Setup Menu” appears, then select “Bluetooth” with the **DIAL** knob.
2. Press the **[ENT]** key, then rotate the **DIAL** knob to select “Vox Function”.
3. Press the **[ENT]** key.
4. Rotate the **DIAL** knob to select the desired voice level to turn on the device.
5. Press the **[ENT]** key to store the setting.
6. Press the **[CLR]** key twice to return to radio operation.

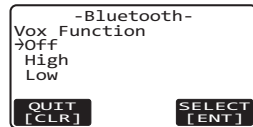
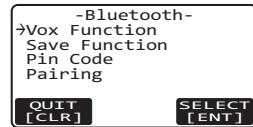
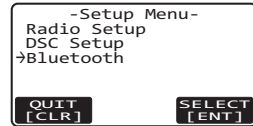

12.2 SAVE FUNCTION

This selection sets up the battery saving mode of the connected Bluetooth devices.

1. Press and hold the **[CALL]** key until “Setup Menu” appears, then select “Bluetooth” with the **DIAL** knob.
2. Press the **[ENT]** key, then rotate the **DIAL** knob to select “Save Function”.
3. Press the **[ENT]** key.
4. Rotate the **DIAL** knob to turn “On” or “Off” the battery saving mode.
5. Press the **[ENT]** key to store the setting.
6. Press the **[CLR]** key twice to return to radio operation.



12.3 PIN CODE

This selection sets up the pin code of the transceiver.

1. Press and hold the **[CALL]** key until “Setup Menu” appears, then select “Bluetooth” with the **DIAL** knob.
2. Press the **[ENT]** key, then rotate the **DIAL** knob to select “Pin Code”.
3. Press the **[ENT]** key.
4. Enter the 4-digit code from the keypad.
5. Press and hold the **[ENT]** key to store the setting.
6. Press the **[CLR]** key twice to return to radio operation.

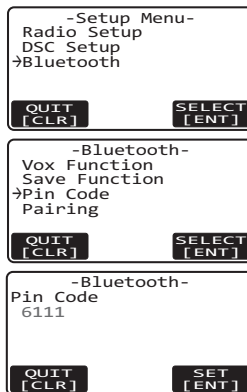

12.4 PAIRING

When using a Bluetooth device with the transceiver for the first time, they must be “paired”.

The pairing procedure is as below when using the **BH-2A** Bluetooth headset as an example.

1. Turn the **BH-2A** off and bring it close to the transceiver.
2. Press and hold the **[CALL]** key until “Setup Menu” appears, then select “Bluetooth” with the **DIAL** knob.
2. Press the **[ENT]** key, then rotate the **DIAL** knob to select “Pairing”.
3. Press the **[ENT]** key. The display will show “Pairing Start?”.
4. Press the **[ENT]** key.
5. Press and hold the power switch of the **BH-2A** until the LED indicator blinks in red and blue alternately.
6. When the **BH-2A** is correctly recognized by the transceiver, the display will show “Pairing Succeeded” and the LED indicator of the **BH-2A** blinks in blue only.
7. Press the **[ENT]** key.
8. Press the **[CLR]** key twice to return to radio operation.

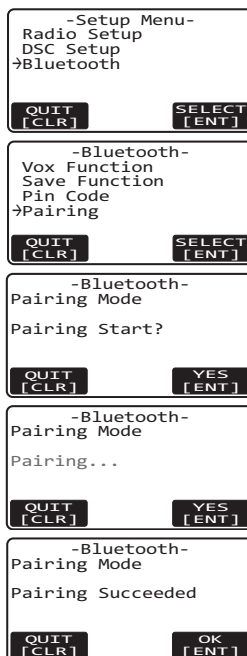



13 RAM3 (CMP30) REMOTE MIC OPERATION

When an optional **RAM3** Remote microphone is connected to the **GX5500S**, all VHF, DSC, and setup menus can be remotely operated. The **RAM3**'s operation is same as the **GX5500S** except the receiver audio volume setting and squelch level setting. The reason for the same operation is to make the operation of the radio and **RAM3** easy. For specific operation of the **RAM3** review sections in the radio manual. The **RAM3** is supplied with 23 feet (7 m) of routing cable and can be extended up to 70 feet (21 m) using two 23-foot extension cables model **CT-100**. The intercom feature can be used between the **RAM3** and the **GX5500S**. In addition, speaker wires are supplied at the panel mount of the routing cable for an external speaker to be connected in noisy environments.

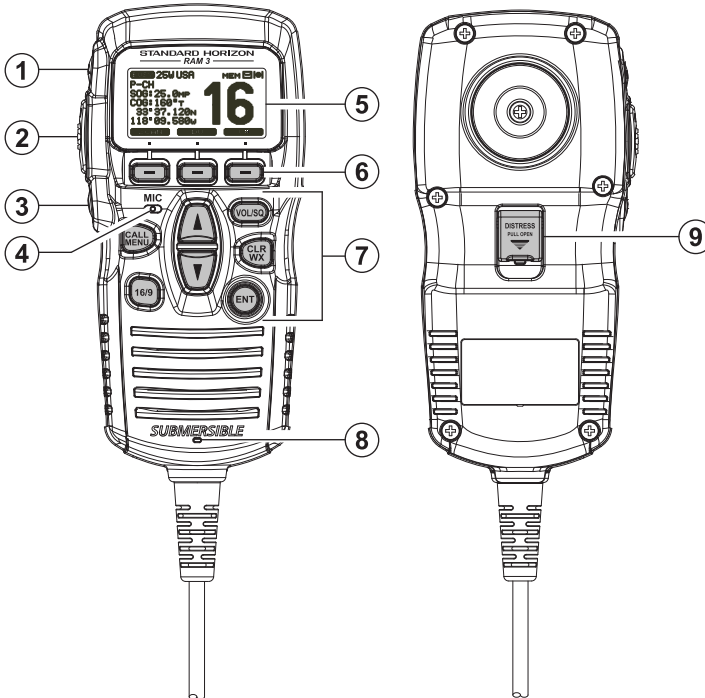
13.1 REMOTE MIC CONTROLS



① KEY

Toggles between high and low power. When the  key is pressed while the transceiver is on CH13 or CH67, the power is temporarily switched from LO to HI until the **PTT** switch is released. The  key does not function on transmit inhibited and low-power only channels.

② **PTT (Push-To-Talk) Switch**

Push this switch to enable the transmitter.

③  **(POWER) Key**

Press and hold this key to turn the transceiver and the remote microphone on or off.

④ **Microphone**

The internal ClearVoice Noise Canceling microphone is located here. When transmitting, position your mouth about 1/2 to 1 inch (1.2 ~ 2.5 cm) away from the small microphone hole. Speak slowly and clearly into the microphone.

⑤ **Display**

Full dot matrix display.

⑥ **Soft Keys**

These three key's functions can be customized by the setup menu mode. When pressing one of these keys briefly, the key functions will appear at the bottom of the display. Refer to section "13.2 ASSIGNING SOFT KEYS" for details.

⑦ **Keypad**

 **Key**

Press this key to access the DSC menu.

Press and hold this key to access the setup menu.

 **Key**

First press: Channel 16 is immediately selected.

Second press: recalls the last selected channel.

Press and hold: selects Channel 9.

 **(UP) /**  **(DOWN) Key**



These keys are used to select channels, adjust the volume and squelch level, and to choose DSC calls, DSC setup and Radio Setup function.

 **Key (Volume Control / Squelch Control)**

First press: volume adjustment mode

Second press: squelch adjustment mode

Third press: exits adjustment mode



When in volume or squelch mode, press the  or  key to adjust the level.

 **Key**

Press to CLEAR a function or menu selection. Press and hold to select

NOAA Weather channels. Press and hold again to exit the weather mode and revert to the radio mode.

Secondary use

Press and hold the  key while pressing the  key to change the mode from USA to International or Canadian.

Key

This key functions as the enter key.

8 Speaker

The internal speaker is located here.













9 [DISTRESS] Key

Used to send a DSC distress call. Refer to section “9 DIGITAL SELECTIVE CALLING”.





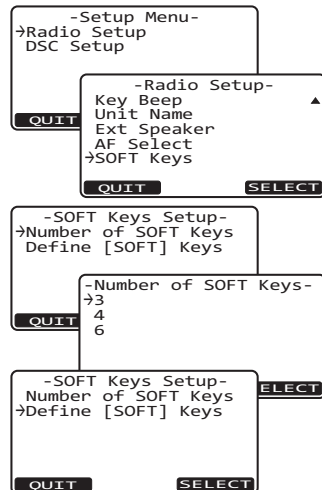

13.2 ASSIGNING SOFT KEYS

This menu item allows selection of the number of soft keys, soft key selection and how long the display will show the soft key icon after a soft key is pressed. The keys may be setup to control the following functions:

DISPLAY	FUNCTION
(NONE)	Assigns no function
SCAN	Starts and stops scanning
DW	Starts and stops dual watch scan
MEM	Sets the scan channel memory on and off
IC	Activates Intercom mode
PA	Activates PA/HAILER mode
FOG	Activates FOG HORN mode

1. Press and hold the  key until “Setup Menu” appears, then select “Radio Setup” with the  or  key.
2. Press the  key, then press the  key to select “SOFT Keys”.
3. Press the  key, then press the  key to select “Number of SOFT Keys”.
4. Press the  key, then press the  or  key to select the number of soft keys (“3”, “4”, “6”).
5. Press the  key, then press the  key to select “Define [SOFT] Keys” (to change the use of selected soft keys). Then press the  key.



6. Press the  or  key to select the key (“SOFT1”, “SOFT2”, “SOFT3” etc), and press the  key. Then press the  or  key to select the new function to be assigned, and press the  key. Available functions are listed in the previous page. Repeat step 6 to program the other soft keys.
7. Press the  key several times to return to radio operation.

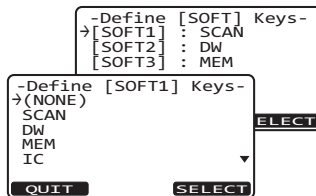

14 MAINTENANCE

The inherent quality of the solid-state components used in this transceiver will provide many years of continuous use. Taking the following precautions will prevent damage to the transceiver.

- Keep the microphone connected or the jack covered at all times to prevent corrosion of electrical contacts.
- Never key the microphone unless an antenna or suitable dummy load is connected to the transceiver.
- Ensure that the supply voltage to the transceiver does not exceed 16 VDC or fall below 11 VDC.
- Use only STANDARD HORIZON-approved accessories and replacement parts.

In the unlikely event of serious problems, please contact your Dealer or our repair facility. Address and phone numbers for this facility, as well as warranty information, are contained in section “**16 WARRANTY.**”

14.1 REPLACEMENT PARTS

Occasionally an owner needs a replacement mounting bracket or knob. These can be ordered from our Parts Department by emailing yaesuparts@yaesu.com or calling:

Marine Division of YAESU U.S.A.

6125 Phyllis Drive, Cypress, California 90630

Telephone (714) 827-7600

Commonly requested parts, and their part numbers are listed below.

- **Power Cord:** T9023306
- **VOL/SQL Knob:** RA0542600
- **Rotary Channel Knob:** RA0542500
- **Mounting Bracket:** RA0544200
- **Mounting Bracket Knob:** RA045910A
- **Microphone Hanger:** RA0458800
- **Microphone Assembly:** M3090118
- **RAM3 Mic Routing Cable Assembly:** S8101512

14.2 FACTORY SERVICE

In the unlikely event that the radio fails to perform or needs servicing, please contact the following:

Standard Horizon

Attention Marine Repair Department

6125 Phyllis Drive, Cypress, California 90630, U.S.A.

Telephone (800) 366-4566

For repairs in Canada

Westcom Marine

488 East 62nd Avenue Vancouver BC V5X2G1

Telephone (604) 327-6280

An "RA" (Return Authorization) number is not necessary to send a product in for service. Include a brief note describing the problem along with your name, return address, phone number, and proof of purchase.

14.3 TROUBLESHOOTING CHART

SYMPTOM	PROBABLE CAUSE	REMEDY
Transceiver fails to power up.	No DC voltage to the transceiver, or blown fuse.	a. Check the 12VDC battery connections and the fuse. b. The PWR key needs to be pressed and held to turn the radio on.
Transceiver blows fuse when connected to power supply.	Reversed power wires.	Check the power cable for DC voltage, or replace the fuse (6A). Make sure the red wire is connected to the positive (+) battery post, and the black wire is connected to the negative (-) battery post. If the fuse still blows, contact your Dealer.
Popping or whining noise from the speaker while engine runs.	Engine noise.	Re-route the DC power cables away from the engine. Add noise suppressor on power cable. Change to resistive spark plug wires and/or add an alternator whine filter.
Sound is not emitted from the internal or external speaker.	Accessory cable.	Check the connections of the accessory cable. External speaker cable (WHITE/SHIELD) shorted together.
Sound is not emitted from the PA speaker.	Accessory cable.	Check the connections of the accessory cable. PA speaker cable (RED/SHIELD) shorted together.
Receiving station reports low transmit power, even with transceiver set to HI power.	Antenna.	Have the antenna checked or test the transceiver with another antenna. If the problem persists, contact your Dealer for servicing.
"HI BATTERY" or "LO BATTERY" message appears when the power is turned on.	The power supply voltage is too high or too low.	Confirm that the connected power supply voltage is between 11 volts and 16.5 volts DC.
"PA ERROR" or "FOG ERROR" message is shown when the PA/FOG mode is activated.	Accessory cable.	Check the connections of the accessory cable. PA speaker cable (RED/SHIELD) shorted together.
Your position is not displayed on the Chart Plotter.	Accessory cable.	Check the accessory cable connection. Some GPS Chart Plotters use the battery ground for NMEA connection.
	Setting of the GPS chart plotter.	Check the output signal format of the GPS chart plotter. This radio requires NMEA0183 format with GGA, GLL, GNS, or RMC sentence as an input signal. If the GPS has a baud rate setting make sure to select 4800 and parity to NONE.
While in PA or FOG listen back modes, AM broadcasts can be heard.	Strong AM radio stations are being pickup up by the speaker wires.	Need to replace the speaker wires to a shielded 2 conductor wire available from Radio Shack part number 278-513. Refer to section " 6.5 ACCESSORY CABLES " for cable connections.

15 CHANNEL ASSIGNMENTS

Tables on the following columns list the VHF Marine Channel assignments for U.S.A. and International use. Below are listed some data about the charts.

1. VTS. Where indicated, these channels are part of the U.S. Coast Guard's Vessel Traffic System.
2. Alpha channel numbers, that is, channel numbers followed by the letter A (such as Channel 07**A**) are **simplex** channels on the U.S.A. or Canadian channel assignments whose counterparts in the International assignments are **duplex** channels. International channels do not use "alpha" numbers. If you call the Coast Guard on Channel 16, they will sometimes ask you to "**go to channel 22 Alpha.**" This is a channel assigned to U.S.A, and Canadian Coast Guards for handling distress and other calls. If your radio is set for **International** operation you will go to Channel 22 instead of 22**A**, and will not be able to communicate with the Coast Guard. To use Channel 22**A**, your radio must be set for **USA** or **Canada** operation, usually by a U/I/C (USA/International/Canada) control or combination of controls. Channel 22 (without an "A") is an **International** duplex channel for port operations. Some radios indicate an "A" adjacent to the alpha channels on the display; on others "alpha" is not indicated but the proper channel is selected based on the U/I/C setting.
3. Bridge-to-Bridge channels (for example, Channel 13) are for use by bridge operators on inter-coastal waterways and rivers. It is also used by marine vessels in the vicinity of these bridges for navigation and for communicating with the bridge operators. Note that a limit of 1 Watt is specified for these channels.
4. The **S/D** column on the chart indicates either S (simplex) or D (duplex). **Simplex** means transmitting and receiving on the same frequency. Only one party at a time can talk, unlike a telephone. Be sure to say "**over**" and release your microphone push-to-talk switch at the end of each transmission. **Duplex** operation involves the use of one frequency for transmitting and a separate frequency for receiving. On channels specified as duplex on the charts, correct mode of operation is established automatically by your radio when you select a channel; you cannot change the mode. And you still must release the push-to-talk switch after each transmission in order to listen to the radio.
5. Channels normally used by recreational boaters are those that include the term "non-commercial" in the **Channel Use** column of the chart. Some of these are shared with other users and some are used only in certain geographic regions.

6. Marine vessels equipped with VHF radios are required to monitor Channel 16.
7. 156.050 MHz and 156.175 MHz are available for port operations and commercial communications purposes when used only within the U.S. Coast Guard designated Vessel Traffic Services (VTS) area of New Orleans, on the lower Mississippi River from the various pass entrances in the Gulf of Mexico to Devil's Swamp Light at River Mile 242.4 above head of passes near Baton Rouge.
8. 156.250 MHz is available for port operations communications use only within the U.S. Coast Guard designated VTS radio protection areas of New Orleans and Houston described in Sec. 80.383. 156.250 MHz is available for intership port operations communications used only within the area of Los Angeles and Long Beach harbors, within a 25- nautical mile radius of Point Fermin, California.
9. 156.550 MHz, 156.600 MHz and 156.700 MHz are available in the U.S. Coast Guard designated port areas only for VTS communications and in the Great Lakes available primarily for communications relating to the movement of ships in sectors designated by the St. Lawrence Seaway Development Corporation or the U.S. Coast Guard. The use of these frequencies outside VTS and ship movement sector protected areas is permitted provided they cause no interference to VTS and ship movement communications in their respective designated sectors.
10. Use of 156.875 MHz is limited to communications with pilots regarding the movement and docking of ships. Normal output power must not exceed 1 watt. 5: 156.375 MHz and 156.650 MHz are available primarily for intership navigational communications. These frequencies are available between coast and ship on a secondary basis when used on or in the vicinity of locks or drawbridges. Normal output power must not exceed 1 watt. Maximum output power must not exceed 10 watts for coast stations or 25 watts for ship stations.
11. On the Great Lakes, in addition to bridge-to-bridge communications, 156.650 MHz is available for vessel control purposes in established vessel traffic systems. 156.650 MHz is not available for use in the Mississippi River from South Pass Lighted Whistle Buoy "2" and Southwest Pass entrance Mid-channel Lighted Whistle Buoy to mile 242.4 above Head of Passes near Baton Rouge. Additionally it is not available for use in the Mississippi River-Gulf Outlet, the Mississippi River-Gulf Outlet Canal, and the Inner Harbor Navigational Canal, except to aid the transition from these areas.
12. Use of 156.375 MHz is available for navigational communications only

in the Mississippi River from South Pass Lighted Whistle Buoy “2” and Southwest Pass entrance Mid channel Lighted Whistle Buoy to mile 242.4 above head of Passes near Baton Rouge, and in addition over the full length of the Mississippi River-Gulf Outlet Canal from entrance to its junction with the Inner Harbor Navigation Canal, and over the full length of the Inner Harbor Navigation Canal from its junction with the Mississippi River to its entry to Lake Pontchartrain at the New Seabrook vehicular bridge.

13. Within 120 km (75 miles) of the United States/Canada border, in the area of the Puget Sound and the Strait of Juan de Fuca and its approaches, 157.425 MHz is half of the duplex pair designated as Channel 88. In this area, Channel 88 is available to ship stations for communications with public coast stations only. More than 120 km (75 miles) from the United States/Canada border in the area of the Puget Sound and the Strait of Juan de Fuca, its approaches, the Great Lakes, and the St. Lawrence Seaway, 157.425 MHz is available for intership and commercial communications. Outside Puget Sound area and its approaches and the Great Lakes, 157.425 MHz is also available for communications between commercial fishing vessels and associated aircraft while engaged in commercial fishing activities.
14. When the frequency 156.850 MHz is authorized, it may be used additionally for search and rescue training exercises conducted by state or local governments.
15. The frequency 156.850 MHz is additionally available to coast stations on the Great Lakes for transmission of scheduled Coded Marine Weather Forecasts (MAFOR), Great Lakes Weather Broadcast (LAWEB) and scheduled Notices to Mariners or Bulletins. F3C and J3C emissions are permitted. Coast Stations on the Great Lakes must cease weather broadcasts which cause interference to stations operating on 156.800 MHz until the interference problem is resolved.
16. The frequency 157.100 MHz is authorized for search and rescue training exercises by state or local government in conjunction with U.S. Coast Guard stations. Prior U.S. Coast Guard approval is required. Use must cease immediately on U.S. Coast Guard request.
17. The duplex pair for channel 20 (157.000/161.600 MHz) may be used for ship to coast station communications.
18. Available for assignment to coast stations, the use of which is in accord with an agreed program, for the broadcast of information to ship stations concerning the environment.

VHF MARINE CHANNEL CHART

CH	U	C	I	S/D	TX	RX	CHANNEL USE
01		X	X	D	156.050	160.650	Public Correspondence (Marine Operator)
01A	X			S	156.050		Port Operation and Commercial. VTS in selected areas
02		X	X	D	156.100	160.700	Public Correspondence (Marine Operator)
03		X	X	D	156.150	160.750	Public Correspondence (Marine Operator)
03A	X			S	156.150		U.S. Government Only, Coast Guard
04			X	D	156.200	160.800	Public Correspondence (Marine Operator), Port operation, ship movement
04A		X		S	156.200		Pacific coast: Coast Guard, East Coast: Commercial fishing
05			X	D	156.250	160.850	Public Correspondence (Marine Operator), Port operation, ship movement
05A	X	X		S	156.250		Port operation. VTS in Seattle
06	X	X	X	S	156.300		Inter-ship Safety
07			X	D	156.350	160.950	Public Correspondence (Marine Operator), Port operation, ship movement
07A	X	X		S	156.350		Commercial
08	X	X	X	S	156.400		Commercial (Inter-ship only)
09	X	X	X	S	156.450		Boater Calling channel, Commercial & Non-commercial (Recreational)
10	X	X	X	S	156.500		Commercial
11	X	X	X	S	156.550		Commercial. VTS in selected areas
12	X	X	X	S	156.600		Port operation. VTS in selected areas
13	X	X	X	S	156.650		Inter-ship Navigation Safety (Bridge-to-bridge)
14	X	X	X	S	156.700		Port operation. VTS in selected areas
15	X			S	---	156.750	Environmental (Receive only)
15		X	X	S	156.750		Commercial, non-commercial, ship movement (1 W)
16	X	X	X	S	156.800		International Distress, Safety and Calling
17	X	X	X	S	156.850		State Controlled (1 W)
18			X	D	156.900	161.500	Port operation, ship movement
18A	X	X		S	156.900		Commercial
19			X	D	156.950	161.550	Port operation, ship movement
19A	X			S	156.950		US: Commercial
19A		X		S	156.950		Coast Guard
20	X	X	X	D	157.000	161.600	Canadian Coast Guard Only, International: port operations and shipment
20A	X			S	157.000		Port operation
21			X	D	157.050	161.650	Port operation, ship movement
21A	X	X		S	157.050		U.S. Government Only, Canadian Coast Guard
22			X	D	157.100	161.700	Port operation, ship movement
22A	X	X		S	157.100		US and Canadian Coast Guard Liaison and maritime Safety Information Broadcasts announced on channel 16
23		X	X	D	157.150	161.750	Public Correspondence (Marine Operator)
23A	X			S	157.150		U.S. Government Only
24	X	X	X	D	157.200	161.800	Public Correspondence (Marine Operator)
25	X	X	X	D	157.250	161.850	Public Correspondence (Marine Operator)
26	X	X	X	D	157.300	161.900	Public Correspondence (Marine Operator)
27	X	X	X	D	157.350	161.950	Public Correspondence (Marine Operator)
28	X	X	X	D	157.400	162.000	Public Correspondence (Marine Operator)

VHF MARINE CHANNEL CHART									
CH	U	C	I	S/D	TX		RX		CHANNEL USE
60		X	X	D	156.025	160.625	Public Correspondence (Marine Operator)		
61			X	D	156.075	160.675	Public Correspondence (Marine Operator), Port operation, ship movement		
61A	X	X		S	156.075		Public Coast: Coast Guard; East Coast: commercial fishing only		
62			X	D	156.125	160.725	Public Correspondence (Marine Operator), Port operation, ship movement		
62A		X		S	156.125		Public Coast: Coast Guard; East Coast: commercial fishing only		
63			X	D	156.175	160.775	Public Correspondence (Marine Operator), Port operation, ship movement		
63A	X	X		S	156.175		Port Operation and Commercial. VTS in selected areas		
64		X	X	D	156.225	160.825	Public Correspondence (Marine Operator), Port operation, ship movement		
64A	X	X		S	156.225		Public Correspondence (Marine Operator), Port operation, ship movement		
65			X	D	156.275	160.875	Public Correspondence (Marine Operator), Port operation, ship movement		
65A	X	X		S	156.275		Port Operations		
66			X	D	156.325	160.925	Public Correspondence (Marine Operator), Port operation, ship movement		
66A	X	X		S	156.325		Port Operations		
67	X	X	X	S	156.375		US: Commercial. Used for Bridge-to-bridge communi-cations in lower Mississippi River. Inter-ship only, Canada: Commercial fishing, S&R		
68	X	X	X	S	156.425		Non-commercial (Recreational)		
69	X	X	X	S	156.475		US: Non-commercial (Recreational), Canada: Commercial fishing only, International: Inter-ship, Port operations and Ship movement		
70	X	X	X	S	156.525		Digital selective calling (voice communications not allowed)		
71	X	X	X	S	156.575		US, Canada: Non-commercial (Recreational), International: Port operations and Ship movement		
72	X	X	X	S	156.625		Non-commercial (Inter-ship only)		
73	X	X	X	S	156.675		US: Port Operations, Canada: Commercial fishing only, International: Inter-ship, Port operations and Ship movement		
74	X	X	X	S	156.725		US: Port Operations, Canada: Commercial fishing only, International: Inter-ship, Port operations and Ship movement		
75	X	X	X	S	156.775		Port Operations (Inter-ship only) (1W)		
76	X	X	X	S	156.825		Port Operations (Inter-ship only) (1W)		
77	X	X		S	156.875		Port Operations (Inter-ship only) (1W)		
77			X	S	156.875		Port Operations (Inter-ship only)		
78			X	D	156.925	161.525	Public Correspondence (Marine Operator), Port operation, ship-movement		
78A	X	X		S	156.925		Non-commercial (Recreational)		
79			X	D	156.975	161.575	Port operation and Ship movement		
79A	X	X		S	156.975		Commercial		

VHF MARINE CHANNEL CHART							
CH	U	C	I	S/D	TX	RX	CHANNEL USE
80			X	D	157.025	161.625	Port operation, ship movement
80A	X	X		S	157.025		Commercial
81			X	D	157.075	161.675	Port operation, ship movement
81A	X			S	157.075		U.S. Government Only - Environmental protection operations
81A		X		S	157.075		Canadian Coast Guard Only
82			X	D	157.125	161.725	Public Correspondence (Marine Operator), Port operation, ship movement
82A	X	X		S	157.125		U.S. Government Only, Canadian Coast Guard Only
83		X		D	157.175	161.775	Canadian Coast Guard Only
83			X	D	157.175	161.775	Public Correspondence (Marine Operator)
83A	X	X		S	157.175		U.S. Government Only, Canadian Coast Guard Only
84	X	X	X	D	157.225	161.825	Public Correspondence (Marine Operator)
85	X	X	X	D	157.275	161.875	Public Correspondence (Marine Operator)
86	X	X	X	D	157.325	161.925	Public Correspondence (Marine Operator)
87		X	X	S	157.375		Port operation, ship movement
87A	X			S	157.375		Public Correspondence (Marine Operator)
88		X	X	S	157.425		Port operation, ship movement
88A	X			S	157.425		Commercial, Inter-ship Only
WX01	X	X	X	D	---	162.550	Weather (receive only)
WX02	X	X	X	D	---	162.400	Weather (receive only)
WX03	X	X	X	D	---	162.475	Weather (receive only)
WX04	X	X	X	D	---	162.425	Weather (receive only)
WX05	X	X	X	D	---	162.450	Weather (receive only)
WX06	X	X	X	D	---	162.500	Weather (receive only)
WX07	X	X	X	D	---	162.525	Weather (receive only)
WX08	X	X	X	D	---	161.650	Weather (receive only)
WX09	X	X	X	D	---	161.775	Weather (receive only)
WX10	X	X	X	D	---	163.275	Weather (receive only)

NOTE: Simplex channels, 03A, 21A, 23A, 61A, 64A, 81A, 82A and 83A CANNOT be lawfully used by the general public in U.S.A. waters.

16 WARRANTY

Marine Products Limited Warranty

PLEASE NOTE

The following "Limited Warranty" is valid for products that have been purchased in the United States and Canada. For limited Warranty details outside the United States, contact the dealer in your country.

STANDARD HORIZON (a division of YAESU U.S.A.) warrants, to the original purchaser only, each new Marine Communications Product ("Product") manufactured and/or supplied by STANDARD HORIZON against defects in materials and workmanship under normal use and service for a period of time from the date of purchase as follows:

Fixed Mount and Portable Transceivers

1 year - if purchased before 01/01/91

3 years - if purchased between 01/01/91 and 01/01/94

3 years Waterproof - if purchased after 01/01/94

Loud hailers

1 year - if purchased before 01/01/91

3 years - if purchased after 01/01/91

Associated Chargers

1 year - if purchased before 01/01/91

3 years - if purchased after 01/01/91

Associated Batteries - 1 year. Note: Batteries will be deemed defective only if storage capacity drops below 80% of rated capacity or if leakage develops.

Associated Accessories - 1 year. Includes: Microphones/Handsets, External Speakers, Antennas, Carrying Accessories, Power Supplies, and Signaling Boards.

To receive warranty service, the purchaser must deliver the Product, transportation and insurance prepaid, to STANDARD HORIZON (a division of YAESU U.S.A.), Attention Marine repairs 6125 Phyllis Drive, Cypress, California 90630, U.S.A. Include proof of purchase indicating model, serial number, and date of purchase. STANDARD HORIZON will return the Product to the purchaser freight prepaid. Products purchased prior to January 1, 1991 will bear the STANDARD HORIZON warranty terms in effect prior to that date.

In the event of a defect, malfunction or failure of the Product during the warranty period, STANDARD HORIZON's liability for any breach of contract

or any breach of express or implied warranties in connection with the sale of Products shall be limited solely to repair or replacement, at its option, of the Product or part(s) therein which, upon examination by STANDARD HORIZON, appear to be defective or not up to factory specifications. STANDARD HORIZON may, at its option, repair or replace parts or subassemblies with new or reconditioned parts and subassemblies. Parts thus repaired or replaced are warranted for the balance of the original applicable warranty.

STANDARD HORIZON will not warrant installation, maintenance or service of the Products. In all instances, STANDARD HORIZON's liability for damages shall not exceed the purchase price of the defective Product.

This warranty only extends to Products sold within the 50 States of the United States of America and the District of Columbia.

STANDARD HORIZON will pay all labor to repair the product and replacement parts charges incurred in providing the warranty service except where purchaser abuse or other qualifying exceptions exist. The purchaser must pay any transportation expenses incurred in returning the Product to STANDARD HORIZON for service.

This limited warranty does not extend to any Product which has been subjected to misuse, neglect, accident, incorrect wiring by anyone other than STANDARD HORIZON, improper installation, or subjected to use in violation of instructions furnished by STANDARD HORIZON, nor does this warranty extend to Products on which the serial number has been removed, defaced, or changed. STANDARD HORIZON cannot be responsible in any way for ancillary equipment not furnished by STANDARD HORIZON which is attached to or used in connection with STANDARD HORIZON's Products, or for the operation of the Product with any ancillary equipment, and all such equipment is expressly excluded from this warranty. STANDARD HORIZON disclaims liability for range, coverage, or operation of the Product and ancillary equipment as a whole under this warranty. STANDARD HORIZON reserves the right to make changes or improvements in Products, during subsequent production, without incurring the obligation to install such changes or improvements on previously manufactured Products.

The implied warranties which the law imposes on the sale of this Product are expressly LIMITED, in duration, to the time period specified above. STANDARD HORIZON shall not be liable under any circumstances for consequential damages resulting from the use and operation of this Product, or from the breach of this LIMITED WARRANTY, any implied warranties, or any contract with STANDARD HORIZON. IN CONNECTION WITH THE SALE

OF ITS PRODUCTS, STANDARD HORIZON MAKES NO WARRANTIES, EXPRESS OR IMPLIED AS TO THE MERCHANTABILITY OR FITNESS FOR A PARTICULAR PURPOSE OR OTHERWISE, EXCEPT AS EXPRESSLY SET FORTH HEREIN.

Some states do not allow the exclusion or limitation of incidental or consequential damages, or limitation on how long an implied warranty lasts, so the above limitations or exclusions may not apply. This warranty gives specific legal rights, and there may be other rights which may vary from state to state.

ONLY PRODUCTS SOLD ON OR AFTER JANUARY 1, 1991 ARE COVERED UNDER THE TERMS OF THIS LIMITED WARRANTY.

ON-LINE WARRANTY REGISTRATION

THANK YOU for buying STANDARD HORIZON (a division of YAESU U.S.A.) products! We are confident your new radio will serve your needs for many years!

Please visit **www.standardhorizon.com** to register your Marine VHF. It should be noted that visiting the website from time to time may be beneficial to you, as new products are released they will appear on the STANDARD HORIZON website. Also a statement regarding product support should be added to the manual.

Product Support Inquiries

If you have any questions or comments regarding the use of the radio, you can visit the STANDARD HORIZON website to send an E-Mail or contact the Product Support team at (714) 827-7600 ext 6300 M-F 8:00-5:00 PST.

In addition to the warranty, STANDARD HORIZON includes a lifetime "flat rate" and "customer loyalty" programs to provide service after the warranty period has expired. If you wish to obtain the flat rate price for out-of-warranty repair, you must include the information on the Owner's Record with the unit when you return it to your Dealer or to STANDARD HORIZON.

Lifetime Flat Rate Service Program: For the original Owner only, for the lifetime of the unit, STANDARD HORIZON will repair the unit to original specifications.

Note: The flat rate amount is payable by the Owner only if STANDARD HORIZON or the STANDARD HORIZON Dealer determines that a repair is needed. After the repair, a 90-day warranty will be in effect from the date of return of the unit to the Owner.

This service program is not available for equipment which has failed as a result of neglect, accident, breakage, misuse, improper installation or modification, or water damage (depending on the product).

17 SPECIFICATIONS

Performance specifications are nominal, unless otherwise indicated, and are subject to change without notice.

17.1 GENERAL

Channels	All USA, International and Canadian
Input Voltage.....	13.8 VDC \pm 20%
Current Drain	
Standby	0.5 A
Receive	1.5 A
Transmit.....	5.0 A (Hi); 1.5 A (Lo)
Dimensions.....	3.5" H x 9.1" W x 5.9" D (90 H x 230 W x 150 D mm)
Flush-Mount Dimensions.....	2.8" H x 8.1" W x 5.1" D (72 H x 205 W x 130 D mm)
Weight	3.2 lbs (1.45 kg)

17.2 TRANSMITTER

Frequency Range	156.025 to 157.425 MHz
RF Output	25 W (Hi); 1 W (Lo)
Conducted Spurious Emissions.....	80 dB (Hi); 66 dB (Lo)
Audio Response	within +1/-3 of a 6 dB/octave pre-emphasis characteristic at 300 to 3000 Hz
Audio Distortion	5 %
Modulation	16K0G3E, for DSC 16K0G2B
Frequency Stability (-4 °F to +140 °F; -20 °C to +60 °C).....	\pm 0.0005%
FM Hum and Noise.....	50 dB

17.3 RECEIVER

Frequency Range	156.050 to 163.275 MHz
Sensitivity	
20 dB Quieting.....	0.35 μ V
12 dB SINAD	0.30 μ V
Squelch Sensitivity (Threshold).....	0.13 μ V
Modulation Acceptance Bandwidth.....	\pm 7.5 kHz
Selectivity (Typical)	
Spurious and Image Rejection	-80 dB
Intermodulation and Rejection at 12 dB SINAD	-80 dB
Audio Output.....	4.5 W
Audio Response	within + 1/-3 of a 6 dB/octave de-emphasis characteristic at 300 to 3000 Hz
Frequency Stability (-4 °F to +140 °F; -20 °C to +60 °C).....	\pm 0.0005 %
Channel Spacing	25 kHz
DSC Format	ITU-R M.493-13
NMEA Input/Output.....	Output - DSC, DSE Input - GLL, GGA, RMC and GNS

17.4 DIMENSIONS

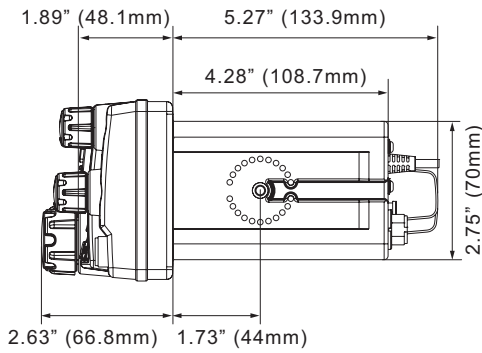
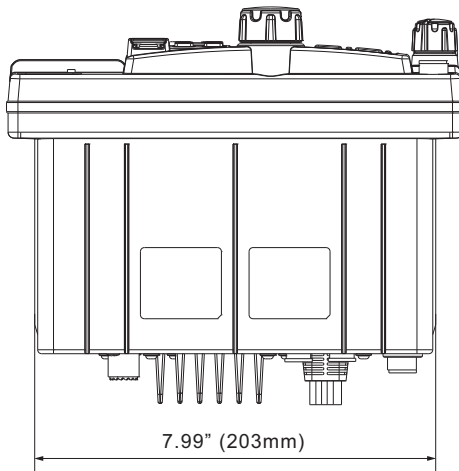
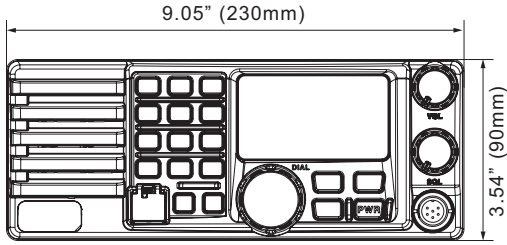

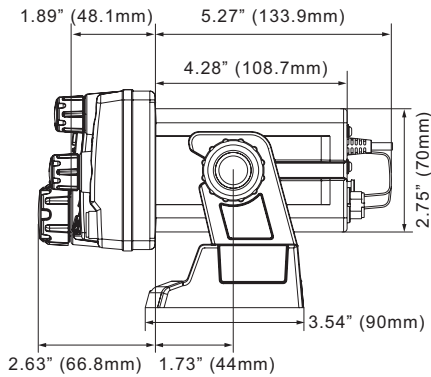
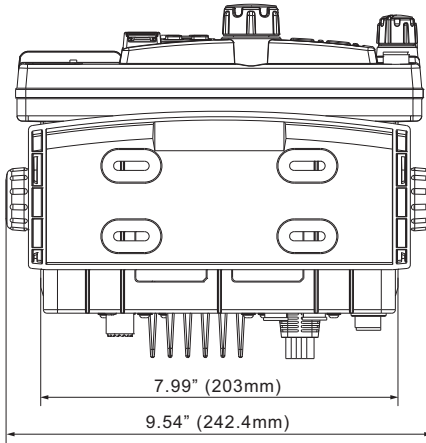
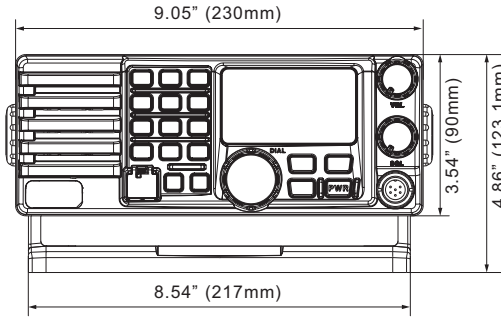

18 FCC RADIO LICENSE INFORMATION

Standard Horizon radios comply with the Federal Communication Commission (FCC) requirements that regulate the Maritime Radio Service.

18.1 STATION LICENSE

An FCC ship station license is no longer required for any vessel traveling in U.S. waters (except Hawaii) which is under 20 meters in length. However, any vessel required to carry a marine radio on an international voyage, carrying a HF single side band radiotelephone or marine satellite terminal is required to have a ship station license. FCC license forms, including applications for ship (605) and land station licenses can be downloaded via the Internet at <http://www.fcc.gov/Forms/Form605/605.html>. To obtain a form from the FCC, call (888) 225-5322.

18.2 RADIO CALL SIGN

Currently the FCC does not require recreational boaters to have a Ship Radio Station License. The USCG recommends the boats registration number and the state to be used when calling another vessel.

18.3 CANADIAN SHIP STATION LICENSING

You may need a license when traveling in Canada. If you need a license contact Industry Canada's nearest field office or regional office or write:

**Industry Canada
Radio Regulatory Branch
Attn: DOSP
300 Slater Street
Ottawa, Ontario
Canada, KIA 0C8**

18.4 FCC / INDUSTRY CANADA INFORMATION

The following data pertaining to the transceiver is necessary to fill out the license application.

Type Acceptance FCC Part 80
Output Power..... 1 Watt (low) and 25 Watts (high)
Emission 16K0G3E, 16K0G2B
Frequency Range 156.025 to 163.275 MHz
FCC Type Number..... K6630283X3S
Industry Canada Type Approval 511B-30283X3S

19 FCC NOTICE

NOTICE

Unauthorized changes or modifications to this equipment may void compliance with FCC Rules. Any change or modification must be approved in writing by STANDARD HORIZON.

NOTICE

This equipment has been tested and found to comply with the limits for a Class B digital device, pursuant to Part 15 of the FCC Rules. These limits are designed to provide reasonable protection against harmful interference in a residential installation. This equipment generates, uses and can radiate radio frequency energy and, if not installed and used in accordance with the instructions, may cause harmful interference to radio communications. However, there is no guarantee that interference will not occur in a particular installation. If this equipment does cause harmful interference to radio or television reception, which can be determined by turning the equipment off and on, the user is encouraged to try to correct the interference by one or more of the following measures:

- Reorient or relocate the receiving antenna.
- Increase the separation between the equipment and receiver.
- Connect the equipment into an outlet on a circuit different from that to which the receiver is connected.
- Consult the dealer or an experienced radio/TV technician for help.

This device complies with part 15 of the FCC rules. Operation is subject to the condition that this device does not cause harmful interference.

Part 15.21: Changes or modifications to this device not expressly approved by YAESU MUSEN could void the User's authorization to operate this device.

STANDARD HORIZON

Nothing takes to water like Standard Horizon

YAESU USA

6125 Phyllis Drive, Cypress, California 90630.

www.standardhorizon.com

Copyright 2013
YAESU MUSEN CO., LTD.
All rights reserved.

No portion of this manual
may be reproduced
without the permission of
YAESU MUSEN CO., LTD.



1303T-DY

Printed in Japan